

XU2-AC - AC voltage relay

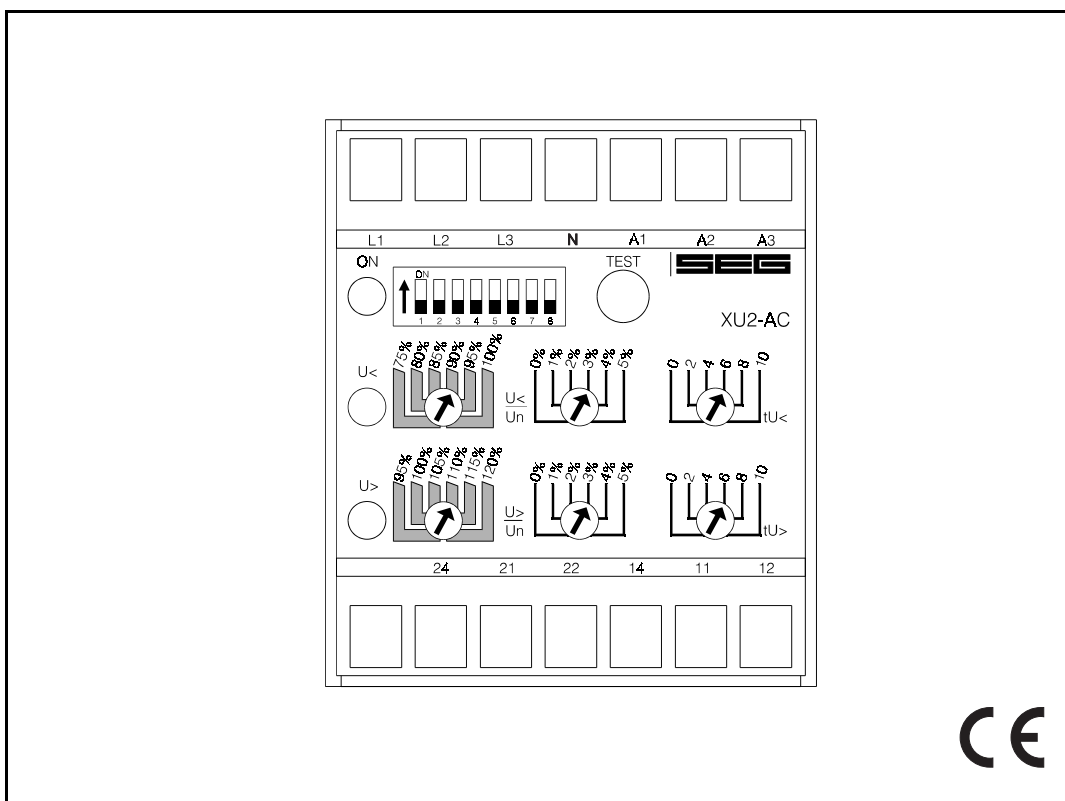

Contents

- 1. Applications and features**
- 2. Design**
- 3. Function**
- 4. Operation and settings**
 - 4.1 Setting of DIP-switches
 - 4.2 Setting of the tripping values
 - 4.3 Communication via serial interface adapter *XRS1*
- 5. Relay case and technical data**
 - 5.1 Relay case
 - 5.2 Technical data

1. Applications and features

The voltage relay, type *XU2-AC*, of the *PROFESSIONAL LINE*, is a digital measuring relay for the supervision of two, three and four wire systems. It protects electrical power generators, consumers or general equipment against inadmissible overvoltage or undervoltage and can be used for low voltage and for medium voltage systems.

In addition it is possible to supervise the phase sequence.

When compared to conventional protection equipment all relays of the *PROFESSIONAL LINE* reflect the superiority of digital protection techniques with the following features:

- High measuring accuracy by digital data processing
- Fault indication via LEDs
- Extremely wide operating ranges of the supply voltage by universal wide range power supply
- Very fine graded wide setting ranges
- Data exchange with process management system by serial interface adapter *XRS1* which can be retrofitted
- RMS - measurement
- Extremely short response time
- Compact design by SMD-technology

In addition to this relay *XU2-AC* has the following special features:

- Different switching hysteresis adjustable
- The tripping periods for overvoltage/undervoltage supervision separately adjustable
- Phase sequence supervision switchable
- Measurement phase-to-neutral or phase-to-phase voltage possible

2. Design

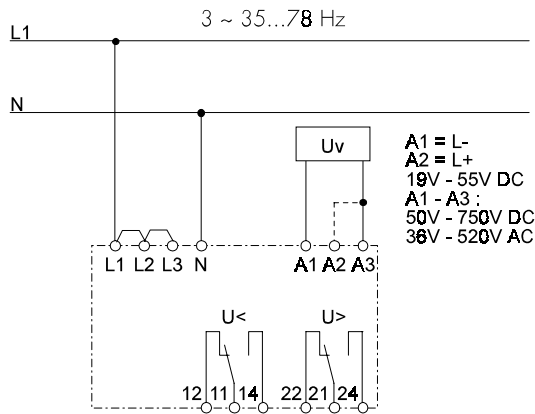

Fig. 2.1: Connecting two-wire system
DIP-switch setting Y

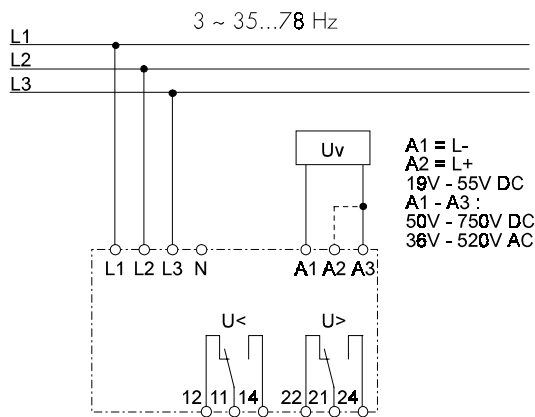

Fig. 2.2: Connection three-wire system
DIP-switch setting Δ

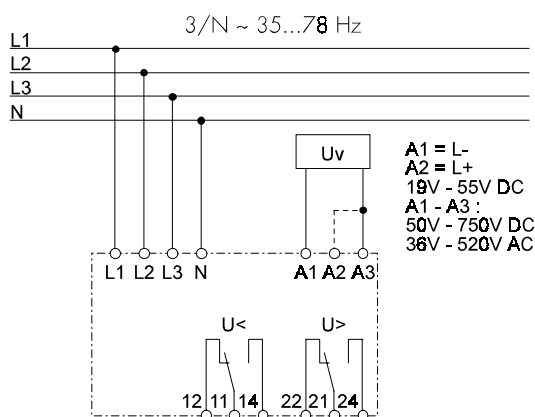

Fig. 2.3 Connection four-wire system
DIP-switch setting Y or Δ

Analog inputs

The analog input signals of AC voltages are connect-
ed to the protection device via terminals L1-L3 and N.

Auxiliary voltage supply

Unit *XU2-AC* can be supplied directly from the
measuring quantity itself or by a secured auxiliary
supply. Therefore a DC or AC voltage must be used.

Unit *XU2-AC* has integrated wide range power
supply. Voltages in the range from 19 - 55 V DC can
be applied at connection terminals A1(L-) and A2(L+).

Terminals A1/A3 are to be used for voltages from
50 - 750 V DC or from 36 - 520 V AC.

Contact positions

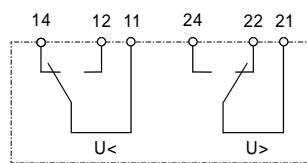

Operation without fault

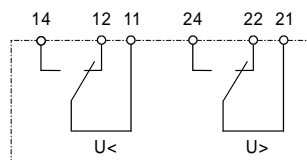

undervoltage in
at least one phase or
dead condition

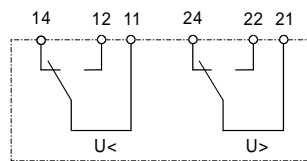

overvoltage in at least
one phase

Fig. 2.4: Contact positions of the output relays

3. Function

Unit *XU2-AC* has an independent overvoltage ($U>$) and undervoltage supervision ($U<$) with separate adjustable pickup values and tripping periods. The noise signals caused by inductive and capacitive coupling are suppressed by an analog RC-filter circuit.

The analog voltage signals are fed to the A/D-converter of the microprocessor and transformed to digital signals through sample-and-hold circuits. The analog signals are sampled with a sampling frequency of $16 \times f_n$, a sampling rate of 1.25 ms for every measuring quantity (at 50 Hz).

The voltages are compared with the set reference values. For three-phase overvoltage supervision the highest voltage in each phase is evaluated, for undervoltage supervision the lowest in each phase.

Pickup of a supervision circuit $U>$ or $U<$ is indicated by flashing of the corresponding LED, after tripping it is steady lit.

4. Operation and settings

All operating elements needed for setting parameters are located on the front plate of the **XU2-AC** as well as all display elements.

Because of this all adjustments of the unit can be made or changed without disconnecting the unit off the DIN-rail.

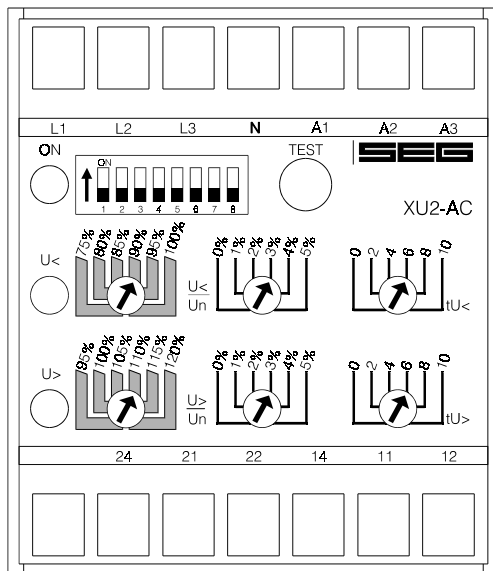

Fig. 4.1: Front plate

For adjustment of the unit the transparent cover has to be opened as illustrated. Do not use force! The transparent cover has two inserts for labels.

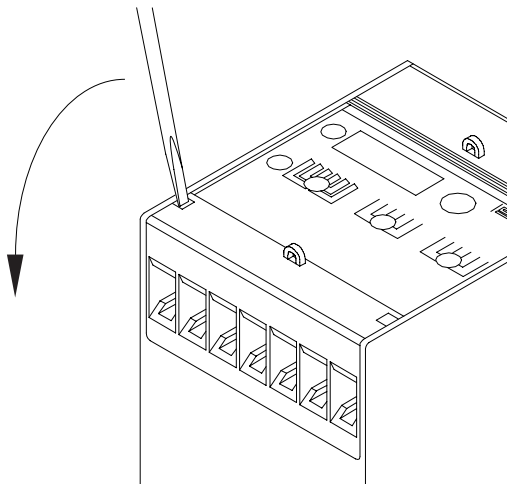

Fig. 4.2: How to open the transparent cover

LEDs

LED "ON" is used for display of the readiness for service (at applied auxiliary voltage U_v) and besides this it flashes at wrong phase sequence (see table under para. 4.1). LEDs $U_>$ and $U_<$ signal pickup (flashing) or tripping (steady light) of the respective function.

Test push button

This push button is used for test tripping of the unit and when pressed for 5 s a check-up of the hardware takes place. Both output relays are tripped and all tripping LEDs light up.

4.1 Setting of DIP-switches

The DIP-switch block on the front plate of the *XU2-AC* is used for adjustment of the nominal values and setting of function parameters:

DIP-switch	OFF	ON	Function
1*	$U_n = 100 \text{ V}$	$U_n = 110 \text{ V}$	setting of rated voltage
2*	$U_n = 100 \text{ V}$	$U_n = 230 \text{ V}$	
3*	$U_n = 100 \text{ V}$	$U_n = 400 \text{ V}$	
4	inactive	active	phase sequence supervision
5	Y	Δ	measuring phase-to-neutral/phase-to-phase voltage
6*	3 %	6 %	setting of switching hysteresis
7*	3 %	10 %	
8	x 0.1 s	x 1 s	multiplier for $t_{U<}$ and $t_{U>}$

Table 4.1: Function of DIP-switches

* Only one of the DIP-switches 1 - 3 and 6 - 7 shall be in "ON" position at the same time.

Rated voltage

The required rated voltage (phase-to-phase voltage) can be set with the aid of DIP-switch 1 - 3 to 100, 110, 230 or 400 V AC. It has to be ensured that only one of the three DIP-switches is switched on. The following DIP-switch configurations for adjustment of the rated voltage are allowed:

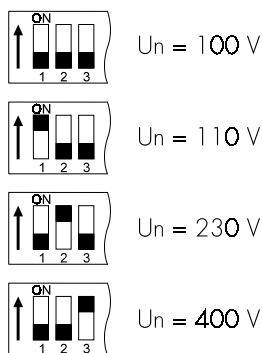

Fig. 4.3: Adjustment of rated voltage

Rated voltage chosen too low does not cause destruction of the unit but leads to wrong measuring results which may lead to false tripping.

Phase sequence supervision

When DIP-switch 4 is in position "ON", the phase sequence supervision is active. Wrong phase sequence is indicated with the flashing LED "ON" and all output relays will be tripped. A correct phase sequence is indicated with the steady lit LED "ON".

The phase sequence supervision is only activated at $U_n > 70 \%$. To prevent tripping when connected to two-wire systems, the phase sequence supervision must not be activated.

Measurement phase-to-neutral/phase-to-phase voltage

The phase-to-neutral (position "OFF") or phase-to-phase voltage (position "ON") can be adjusted by means of switching over the DIP-switch 5.

Note:

By measuring phase-to-neutral voltage a displacement of the neutral point will be detected.

If the phase-to-phase voltage is measured, a displacement of the neutral point will not be detected.

Instead of it the values of the three phase-to-phase voltages in the phase triangle will be detected.

The kind of connection Y or Δ is dependent on the item to be protected, i.e. a three phase motor (without neutral) in a four wire system \Rightarrow select Δ .

Switching hysteresis

The switching hysteresis of both tripping relays can be adjusted with the aid of DIP switches 6 and 7 to 3, 6 or 10 % of the tripping values. As for the rated voltage, it has to be ensured that only one of the two DIP-switches is switched on.

The following adjustments of the switching hysteresis for $U_{>}$ and $U_{<}$ are possible:

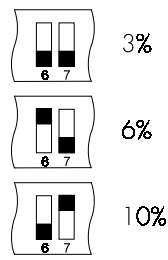

Fig. 4.4: Adjustment of the switching hysteresis

Supervision of single-phase AC-voltages

For the supervision of single-phase AC-voltages terminals L1-L3 must be short-circuited. DIP-switch 4 and 5 must be in position "OFF".

4.2 Setting of the tripping values

The *PROFESSIONAL LINE* units have the unique possibility of high accuracy fine adjustments. For this, two potentiometers are used. The coarse setting potentiometer can be set in discrete steps of 5 %. A second fine adjustment potentiometer is then used for continuously variable setting of the final 0 - 5 %. Adding of the two values results in the precise tripping value.

Undervoltage element

The undervoltage element can be set in the range from 75 to 105 % U_n with the aid of the potentiometer illustrated on the following drawing.

Example:

A tripping value $U_{<}$ for 93 % U_n is to be set. The set value of the right potentiometer is just added to the value of the coarse setting potentiometer. (The arrow of the coarse setting potentiometer must be inside the marked bar, otherwise no defined setting value).

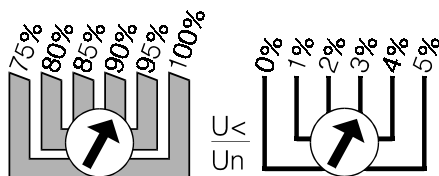

Fig. 4.5: Adjustment example

Overvoltage tripping element

The overvoltage tripping element is adjustable in the range from 95 - 125 % U_n . The adjustment is carried out in a similar way to the undervoltage adjustment.

Time delays

The time delays for over-/undervoltage, $t_{U<}$ or $t_{U>}$ can be adjusted infinitely variably in the range from 0 - 1 s (DIP-switch 8 = OFF) or 0 - 10s (DIP-switch 8 = ON).

4.3 Communication via serial interface adapter XRS1

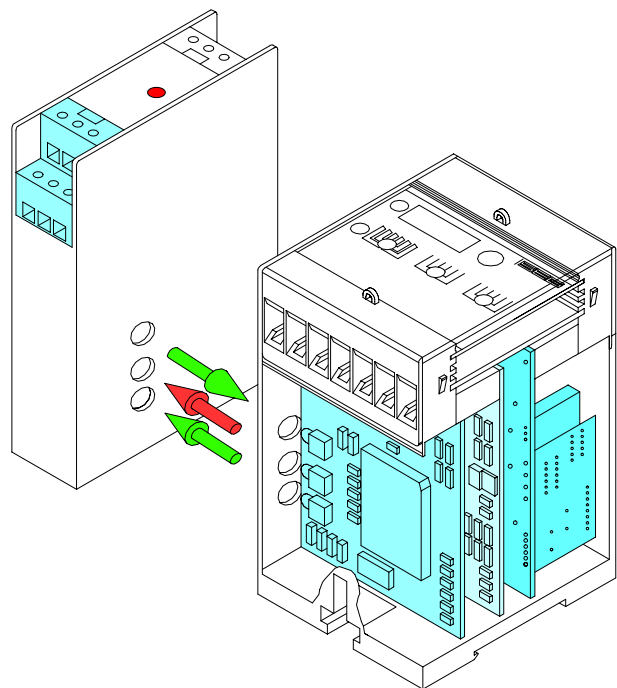

Fig. 4.6: Communication principle

For communication of the units with a superior management system, the interface adapter *XRS1* is available for data transmission, including operating software for our relays. This adapter can easily be retrofitted at the side of the relay. Screw terminals simplify its installation. Optical transmission of this adapter makes galvanic isolation of the relay possible. Aided by the software, actual measured values can be processed, relay parameters set and protection functions programmed at the output relays. Information about unit *XRS1* in detail can be taken from the description of this unit.

5. Relay case and technical data

5.1 Relay case

Unit *XU2-AC* is designed to be fastened onto a DIN-rail acc. to DIN EN 50022, the same as all units of the *PROFESSIONAL LINE*.

The front plate of the unit is protected with a sealable transparent cover (IP40).

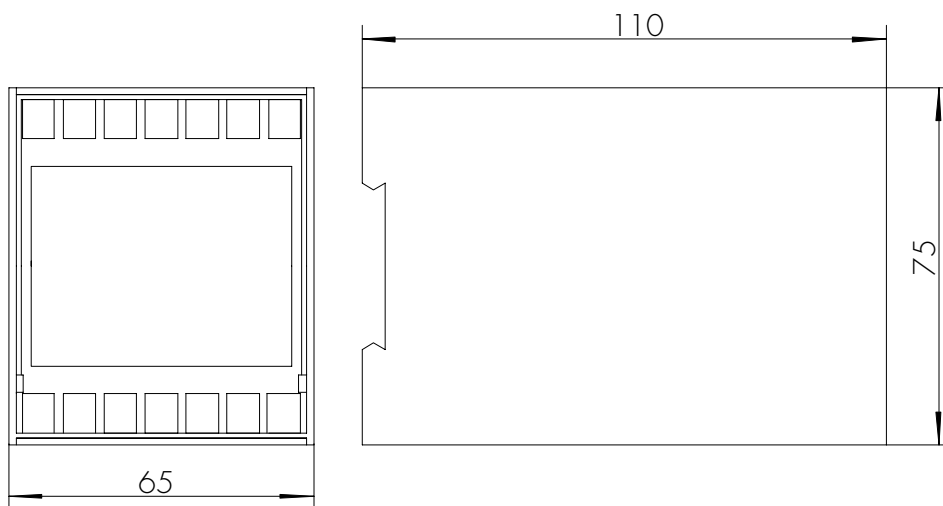

Fig. 5.1: Dimensional drawings

Connections terminals

The connection of up to a maximum of $2 \times 2.5 \text{ mm}^2$ cross-section conductors is possible. For this the transparent cover of the unit has to be removed (see para. 4).

5.2 Technical data

Connection possibilities:

System voltage	Setting Un	Connection	Setting	Connection	Setting	Connection	Setting
100 / 58 V	100 V	58 V single-phase	Y	100 V 3-phase	Δ	100/58 V four wire	Y/Δ
110 / 63 V	110 V	63 V single-phase	Y	110 V 3-phase	Δ	110/63 V four wire	Y/Δ
230 / 130 V	230 V	130 V single-phase	Y	230 V 3-phase	Δ	230/130 V four wire	Y/Δ
400 / 230 V	400 V	230 V single-phase	Y	400 V 3-phase	Δ	400/230 V four wire	Y/Δ
690 / 400 V		not possible		not possible		not possible	

Table 5.1: Connection possibilities

Measuring input circuits

Rated data

Rated voltage Un:	100, 110, 230, 400 V AC (phase-to-phase voltage)
Rated frequency range:	35 - 78 Hz (35 - 66 Hz at communication via serial interface)
Power consumption in voltage circuit:	1 VA per phase at Un
Thermal capacity of the voltage circuit:	continuously 520 V AC

Auxiliary voltage

Rated auxiliary voltage Uv/	36 - 520 V AC (f = 35 - 78 Hz) or 50 - 750 V DC / 4 W (terminals A1-A3)
Power consumption:	19 - 55 V DC / 3 W (terminals A1 (L-) and A2 (L+))

Common data

Dropout to pickup ratio:	depending on the adjusted hysteresis
Resetting time from pickup:	<50 ms
Returning time from trip:	500 ms
Minimum initialization time after supply voltage has applied:	100 ms
Minimum response time when the supply voltage is available:	50 ms
Time lag error class index E:	±20 ms

Output relay

Number of relays:	2
Contacts:	1 changeover contact for each trip relay
Maximum breaking capacity:	ohmic 1250 VA/AC resp. 120 W/DC inductive 500 VA/AC resp. 75 W/DC
Max. rated voltage:	250 V AC 220 V DC ohmic load I _{max.} = 0,2 A inductive load I _{max.} = 0,1 A at L/R ≤ 50 ms 24 V DC inductive load I _{max.} = 5 A
Minimum load:	1 W / 1 VA at U _{min} ≥ 10 V
Maximum rated current:	5 A
Making current (16 ms):	20 A
Contact life span:	10 ⁵ operations at max. breaking capacity

System data

Design standard:	VDE 0435 T303; IEC 0801 part 1-4, VDE 0160; IEC 255-4; BS 142; VDE 0871
Temperature range at storage and operation:	- 25 °C to + 70 °C
Constant climate class F acc. to DIN 40040 and DIN IEC 68, T.2-3:	more than 56 days at 40 °C and 95 % relative humidity
High voltage test acc. to VDE 0435, part 303	
Voltage test:	2,5 kV (eff) /50 Hz; 1 min
Surge voltage test:	5 kV; 1.2/50 μ s, 0.5 J
High frequency test:	2,5 kV / 1 MHz
Electrostatic discharge (ESD) acc. to IEC0801 part 2:	8 kV
Radiated electromagnetic field test acc. to IEC 0801 part 3:	10 V/m
Electrical fast transient (burst) acc. to IEC 0801 part 4:	4 kV/2.5 kHz, 15 ms
Radio interference suppression test as per DIN 57871 and VDE 0871:	limit value class A
Repeat accuracy:	1 %
Basic time delay accuracy.	0,5 % or \pm 25 ms
Accuracy of the specific rated values:	Un = 100 V / 110V / 230 V / 400 V 1 % Uphase-to-neutral 1 % Uphase-to-phase
Temperature effect:	0.02 % per K
Frequency effect:	45 - 66 Hz no tolerance 35 - 45 Hz and 66 - 78 Hz 1 %
Mechanical test	
Shock:	class 1 acc. to DIN IEC 255-21-2
Vibration:	class 1 acc. to DIN IEC 255-21-1
Degree of protection:	
Front panel:	IP40 at closed front cover
Weight:	approx. 0.5 kg
Mounting position:	any
Relay case material:	self-extinguishing
GL-Approbation:	94657-94HH

Parameter	Setting range	Graduation
U<	75 - 105 % Un	continuously variable
U>	95 - 125 % Un	continuously variable
tU</tU>	0 - 1 s / 0 - 10 s	continuously variable
Hysteresis for U> and U<	3, 6, 10 %	

Table 5.2: Setting ranges and graduation

Technical data subject to change without notice!

Setting-list XU2-AC

Project: _____ SEG job.no.: _____

Function group: = _____ Location: + _____ Relay code: - _____

Relay functions: _____ Date: _____

Setting of parameters

Function		Unit	Default settings	Actual settings
U<	Undervoltage	% Un	75	
U>	Overvoltage	% Un	95	
tU<	Time delay for U<	s	0	
tU>	Time delay for tU>	s	0	

DIP-switch	Function	Default settings	Actual settings
1*	Adjustment of rated voltage	100 V	
2*		100 V	
3*		100 V	
4	Phase sequence supervision	inactive	
5	Measuring phase-to-neutral / phase-to-phase voltage	Y	
6*	Hysteresis for U< and U>	3 %	
7*		3 %	
8	Multiplier for tU< and tU>	x 0.1 s	

*Only one of the DIP-switches 1 - 3 or 6 - 7 shall be in „ON“-position at the same time.



Schaltanlagen-Elektronik-Geräte GmbH & Co. KG

Abteilung Gerätevertrieb / Electronic Devices Sales Department

Krefelder Weg 47 · D - 47906 Kempen (Germany)

Postfach 10 07 67 (P.O.B.) · D - 47884 Kempen (Germany)

Tel.: +49 (0)21 52 1 45-1 · Fax.: +49 (0)21 52 1 45-3 54

e-mail: electronics@avksege.com