

XG2 - Generator- /Mains Monitor

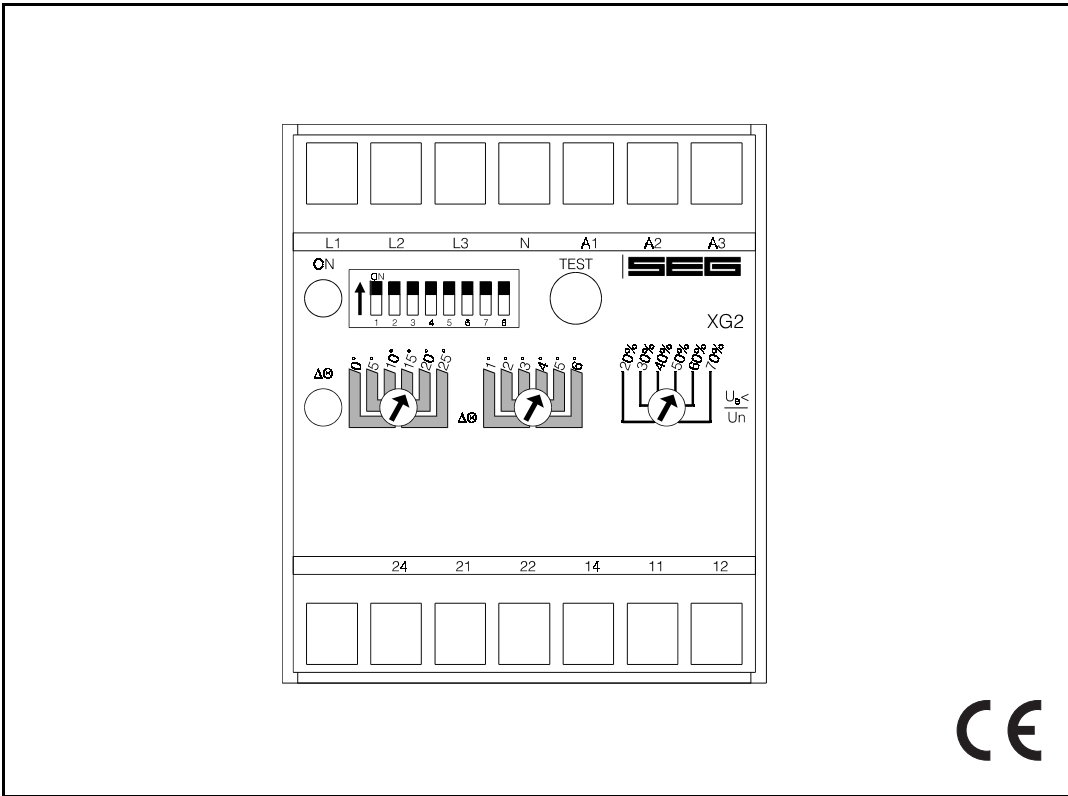

Contents

- 1. Applications and features**
- 2. Design**
- 3. Function**
- 4. Operation and settings**
 - 4.1 Setting of DIP-switches
 - 4.2 Setting of tripping values
 - 4.3 Communication via serial interface adapter XRS1
- 5. Relay case and technical data**
 - 5.1 Relay case
 - 5.2 Technical data

1. Applications and features

Vector surge relay *XG2* of the *PROFESSIONAL LINE* provides reliable protection for generators in parallel operation with the mains, by switching off very quickly in case of mains failure. Supervision of the phase sequence is also possible.

When compared to conventional protection equipment all relays of the *PROFESSIONAL LINE* reflect the superiority of digital protection techniques with the following features:

- High measuring accuracy by digital data processing
- Fault indication via LEDs
- Extremely wide operating ranges of the supply voltage by universal wide range power supply
- Very fine graded wide setting ranges
- Data exchange with process management system by serial interface adapter *XRS1* which can be retrofitted
- RMS measurement
- Extremely short response time
- Compact design due to SMD-technology

In addition to this relay *XG2* has the following special features:

- Supervision of the phase sequence
- Switching over from 1-phase measurement to 3-phase measurement

2. Design

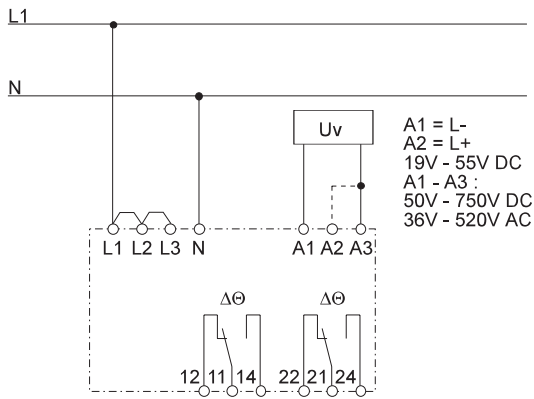

Fig. 2.1: Connection two-wire system

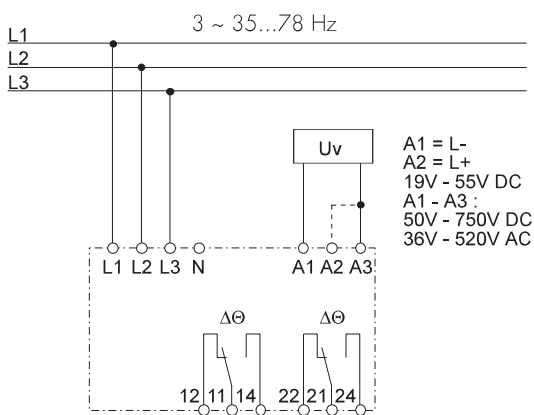

Fig. 2.2: Connection three-wire system Δ

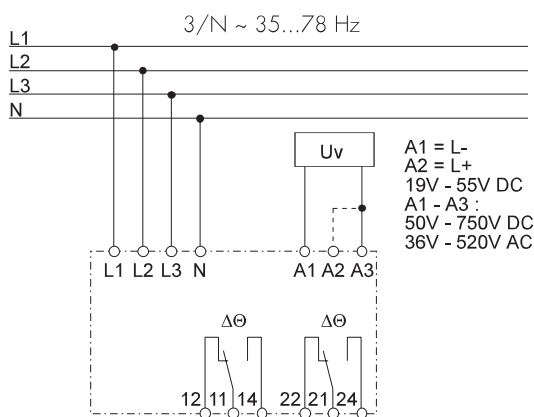

Fig. 2.3: Connection four-wire system Y/ Δ

Analog inputs

The analog voltage input signals are connected to the protection device via terminals L1-L3 and N.

Auxiliary voltage supply

Unit **XG2** can be supplied directly from the measuring quantity itself or by a secured auxiliary supply. Therefore a DC or AC voltage must be used.

Unit **XG2** has an integrated wide range power supply. Voltages in the range from 19 - 55 V DC can be applied at connection terminals A1(L-) and A2(L+). Terminals A1/A3 are to be used for voltages from 50 - 750 V DC or from 36 - 520 V AC.

Contact positions

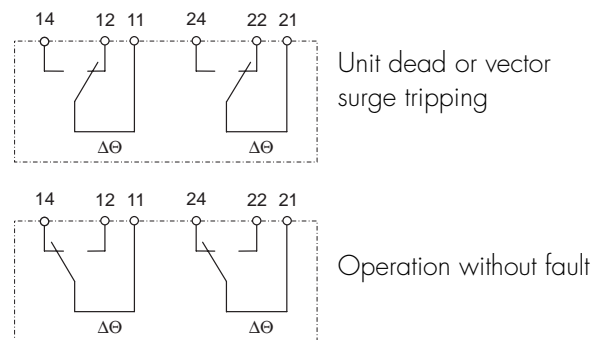

Fig. 2.4: Contact positions of the output relays

3. Function

The vector surge supervision protects synchronous generators in mains parallel operation due to very fast decoupling in case of mains failure. Very dangerous are mains auto reclosing for synchronous generators. The mains voltage returning after 300 ms can hit the generator in asynchronous mode. The same very fast decoupling is also necessary in case of transient mains failures. Generally there are two different applications:

- a) Only mains parallel operation no single operation. In this application the vector surge supervision protects the generator by tripping the generator circuit breaker in case of mains failure.
- b) Mains parallel operation and single operation. For this application the vector surge supervision trips the mains circuit breaker. Here it is insured that the gen.-set is not blocked when it is required as the emergency set.

A very fast decoupling in case of mains failures for synchronous generators is known as very difficult. Voltage supervision units cannot be used because the synchronous alternator as well as the consumer impedance support the decreasing voltage. The voltage reaches the threshold of voltage supervision unit because of this reason after a couple of 100 msec., and therefore a safe detection of auto reclosing in the mains is not possible with single-voltage supervision units.

Also frequency relays cannot be used, because even a fully overloaded generator decreases the speed after 100 msec. Current protection relays detects the fault, by existing short circuit currents. Power sensing relays can also detect but cannot avoid the decreasing change of power to short circuit power. A problem is also the failure tripping of this kind of devices when to suddenly loading the generator. Without any mentioned limitation, the **XG2** described detects mains failures within 70 msec., because it was specially designed for such kind of applications, where the kind of fault requires a very fast decoupling from the mains.

The total tripping time lies still under 170 msec. even, when the circuit breaker time and the relay time is added. Requirement for a tripping of the generator mains monitor is a change of power of more than 15 - 20 % nominal power. Slow changes of the system frequency, for example controlling of the governor does not trip the relay.

Short circuits in the mains can also trip the relay, because a vector surge higher than the preset threshold can be detected. The value of the vector surge is dependent on the short circuit distance to the generator. This function offers the advantage for the utility that the mains short circuit capacity and therefore the energy feeding the short circuit is limited.

Measuring principle of vector surge

When a synchronous alternator is loaded, the rotor displacement angle is built between the terminal voltage (mains voltage \underline{U}_1) and the synchronous electromotive force (\underline{U}_p). Therefore a voltage difference ΔU is built between \underline{U}_p and \underline{U}_1 (fig. 3.1).

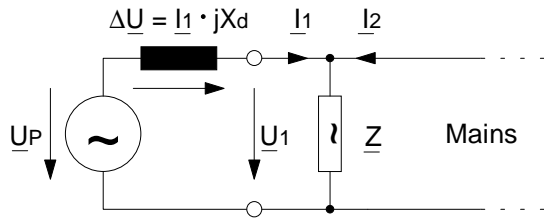

Fig. 3.1: Equivalent circuit of synchronous generator in parallel with the mains

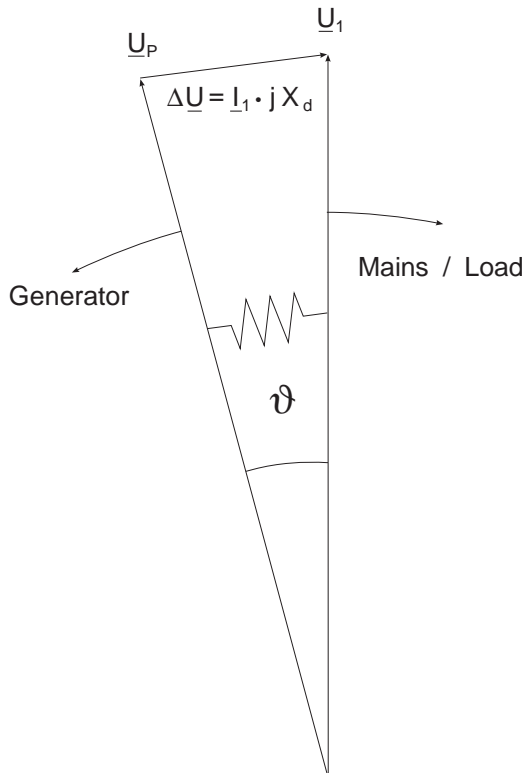

Fig. 3.2: Voltage vectors at mains parallel operation

The rotor displacement angle ϑ between stator and rotor is depending of the mechanical moving torque of the generator shaft. The mechanical shaft power is balanced with the electrical fed mains power, and therefore the synchronous speed keeps constant (fig. 3.2).

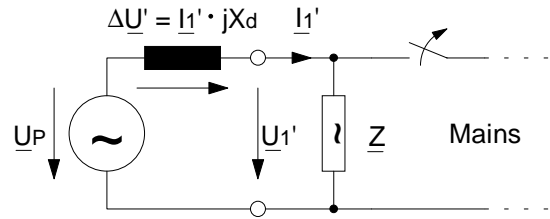

Fig. 3.3 Equivalent circuit at mains failure

In case of mains failure or auto reclosing the generator suddenly feeds a very high consumer load. The rotor displacement angle is decreased repeatedly and the voltage vector \underline{U}_1 change its direction \underline{U}_1' (figure 3.3 and 3.4).

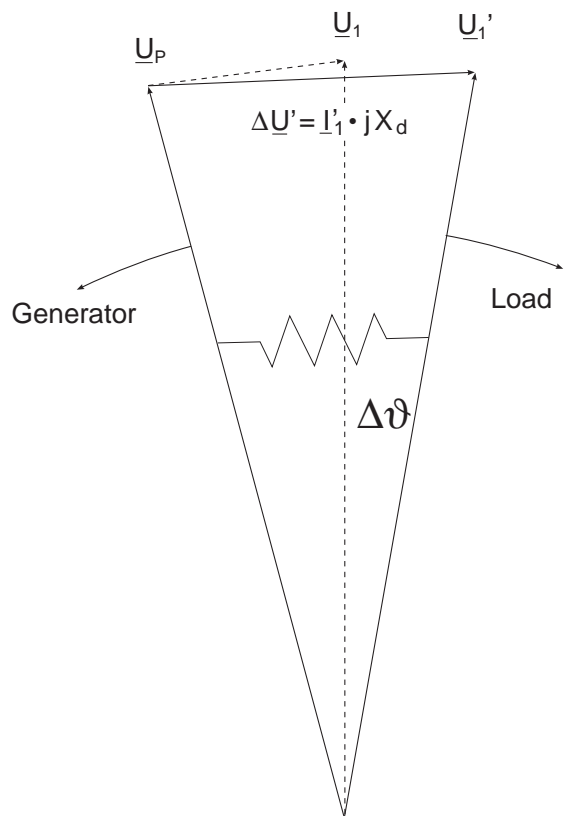

Fig. 3.4: Voltage vectors at mains failure

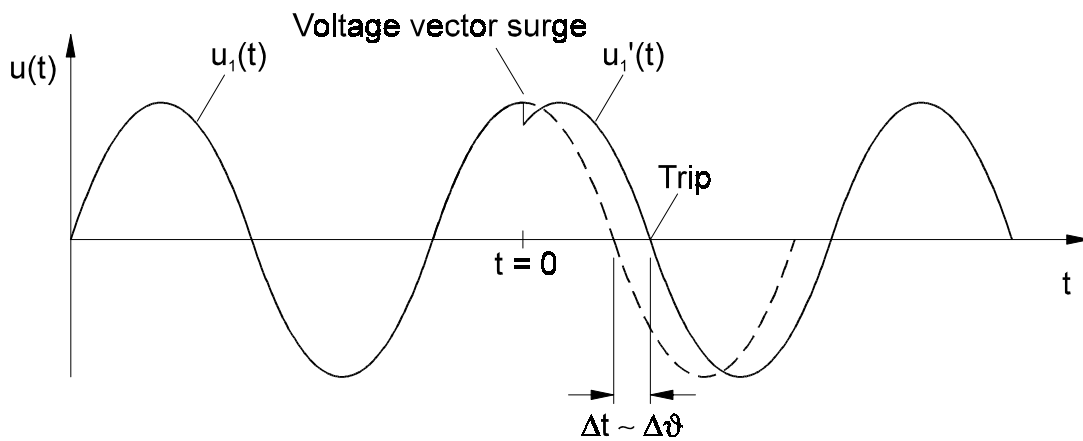

Fig. 3.5: Voltage vector shift

As shown in the time diagram the voltage jumps to another value and the phase position changes. This procedure is named phase or vector surge.

The **XG2** are continuously measuring the cycles, starting each zero message up ward slope. The cycle time is internally compared to the quartz table reference time. In case of vector surge as shown in fig. 3.5, the zero message is delayed and the device trips instantaneously. The trip angle $\Delta\theta$ and consequently the sensitivity of the vector surge detection is adjustable.

Information for use

Although the vector surge relay guarantees very fast and reliable detection of mains failures under nearly all operational conditions of mains parallel running alternators, the following borderline cases have to be considered accordingly:

a) No or only insignificant change of power flow at the utility connection point when a mains failure occurs

This can arise during peak lopping operation or in CHP stations (Combined Heat and Power) where the power flow between power station and the public grid may be very low. For detection of a vector surge at parallel running alternators, the load change must be at least 15 - 20 % of the rated power. If the active load at the utility connection point is regulated to a minimal value and a high resistance mains failure occurs, then there are no vector surge nor power and frequency changes and the mains failure is not detected.

This can only happen if the public grid is disconnected near the power station and so the alternators are not additionally loaded by any consumers. At distant mains failures the synchronous alternators are abruptly loaded by remaining consumers which leads directly to a vector surge and so mains failure detection is guaranteed.

If such a situation occurs the following has to be taken into account:

In case of an undetected mains failure, i.e. with the mains coupling C.B. in operation, the vector surge relay reacts upon the first load change causing a vector surge and isolates the mains C.B.

For detecting high resistance mains failures a zero sequence relay with an adjustable time delay can be used. A time delay is needed to allow regulating actions where the current may reach "zero" at the utility connection point. At high resistance mains failures, the mains coupling C.B. is tripped by the zero sequence relay after the time delay.

To prevent asynchronous switching on, an automatic restart by the public grid should be not possible during this time delay.

As a further measure the load regulation at the utility connection point should be such that an active energy of 5 % of the alternator rated power is always flowing.

b) Short circuit type loading of the alternators at distant mains failures

At any distant mains failure, the remaining consumers cause sudden short circuit type loading of the power station alternators. The vector surge relay detects the mains failure in about 70 ms and switches off the mains coupling C.B. The total switch off time is about 150 - 170 ms. If the alternators are provided with an extremely fast short circuit protection e.g. able to detect di/dt , the alternators might be switched off unselectively by the alternator C.B., which is not desirable because the power supply for the station is endangered and later on synchronized changeover to the mains is only possible after manual reset of the over-current protection.

To avoid such a situation, the alternator C.B.s must have a delayed short circuit protection. The delay time must be long enough so that mains disconnection by the vector surge relay is guaranteed.

4. Operation and settings

All operating elements needed for setting parameters are located on the front plate of the XG2 as well as all display elements.

Because of this all adjustments of the unit can be made or changed without disconnecting the unit from the DIN-rail.

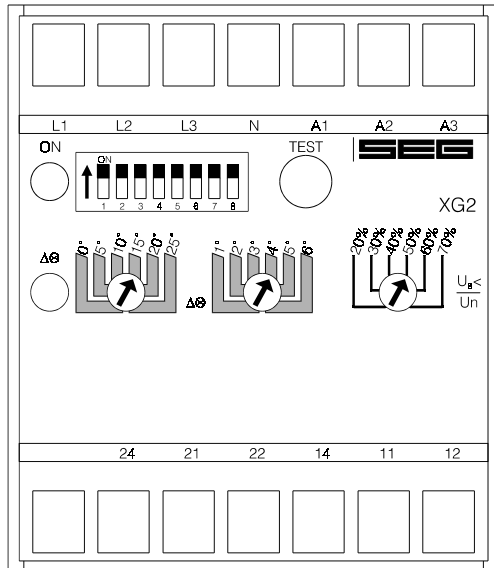

Fig. 4.1: Front plate

For adjustment of the unit the transparent cover has to be opened as illustrated. Do not use force! The transparent cover has two inserts for labels.

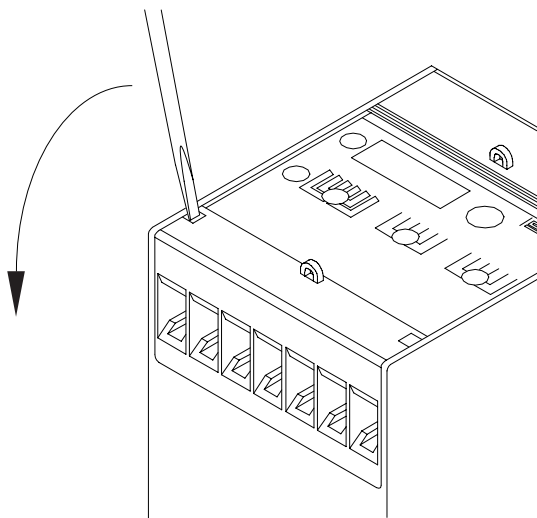

Fig. 4.2: How to open the transparent cover

LEDs

LED "ON" is used for display of the readiness for operation (at applied auxiliary voltage U_v) and flashes at wrong phase sequence. LED $\Delta\theta$ signals tripping of the vector surge function.

Test push button

This push button is used to test tripping of the relay and when pressed for 5 s a check up of the hardware takes place. Both output relays are tripped and the tripping LED lights up.

4.1 Setting of DIP-switches

The DIP switch block on the front plate of unit **XG2** is used for adjustment of the nominal values and setting of function parameters:

DIP-switch	OFF	ON	Functions
1*	$U_n = 100\text{ V}$	$U_n = 110\text{ V}$	Setting of rated voltage
2*	$U_n = 100\text{ V}$	$U_n = 230\text{ V}$	
3*	$U_n = 100\text{ V}$	$U_n = 400\text{ V}$	
4	Inactive	Active	Phase sequence supervision
5	1-phase	3-phase	Single/three-phase measurement
6			
7			
8			

Table 4.1: Function of DIP-switches

* Only one of the DIP-switches 1 - 3 shall be in „ON“ position at the same time.

Rated voltage

The required rated voltage (phase-to-phase voltage) can be set with the aid of DIP-switch 1 - 3 to 100, 110, 230 or 400 V AC. It has to be ensured that only one of the three DIP-switches is switched on.

The following DIP-switch configurations for adjustment of the rated voltage are allowed:

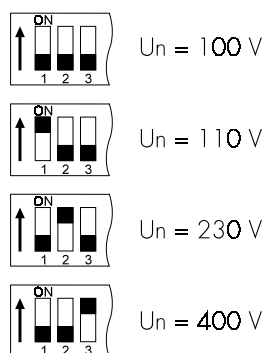

Fig. 4.3: Adjustment of rated voltage

Rated voltage chosen too low does not cause destruction of the unit but leads to wrong measuring results which may lead to false tripping.

Phase sequence supervision

If DIP switches 4 and 5 are in position "ON", the phase sequence supervision is active. Wrong phase sequence is indicated with the flashing LED "ON" and all output relays will be tripped. A correct phase sequence is indicated with the permanently lit LED "ON".

The phase sequence supervision is activated when $U_b <$ is exceeded. When connected to two-wire systems, the phase sequence supervision must be switched off.

Supervision of single- and three-phase AC voltages

For supervision of single phase AC voltages DIP-switch 4 + 5 must be switched off. If three phases should be supervised, DIP switch 5 has to be in position "ON". For supervision of 3-wire systems without N the DIP switch 5 must be in position ON.

Note!

Single-phase supervision (DIP switch 5 = OFF) can also be switched on with three-phase connection. The device triggers if in at least one of the three phases the set limit value $\Delta\Theta$ is exceeded and the surge in the remaining phases is not bigger than 1° in the opposite direction.

The three-phase supervision (DIP switch 5 = ON) trips if in at least two of the three phases the set limit value is exceeded and the surge in the remaining phase is not bigger than 1° in the opposite direction. The vector surge supervision is only active when the blocking period of $t_v = 5\text{ s}$ has expired and the phase voltages exceed the blocking voltage $U_b <$.

Thanks to the criterium of the angular surges in the opposite direction, unintended disconnection during transient balancing processes is prevented.

4.2 Setting of tripping values

The *PROFESSIONAL LINE* units have the unique possibility of high accuracy fine adjustments. For this, two potentiometers are used. The course setting potentiometer can be set in discrete steps of 5° . A second fine adjustment potentiometer is then used for setting of the final $1 - 6^\circ$. Adding of the two values results in the precise tripping value.

Vector surge tripping

By using the potentiometer shown on the following figure, the vector surge trip relay can be adjusted in a range from 1° to 31° in 1° steps.

Example:

The requested tripping value to be set is 19° . To achieve this, the setting value of the potentiometer on the right is simply to be added to the value of the potentiometer on the left. (The arrow of the potentiometers must always be in the middle of the marked bar, otherwise a definite setting value is not possible).

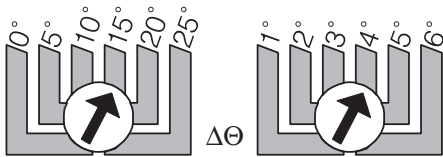

Fig. 4.4: Adjusting example

Blocking time

To prevent wrong trippings caused by oscillations after the synchronizing procedure, tripping is blocked after applying the measuring voltage for a fixed time $t_v = 5$ s.

If the measuring voltage drops below $U_b <$ the blocking time t_v is reset. t_v is activated again if the measuring voltage exceeds $U_b <$.

Blocking voltage

With the aid of potentiometer $U_b </U_n$ the blocking voltage can be set continuously variable in the range from 20 - 70 % U_n (phase-to-phase voltage).

4.3 Communication via serial interface adapter XRS1

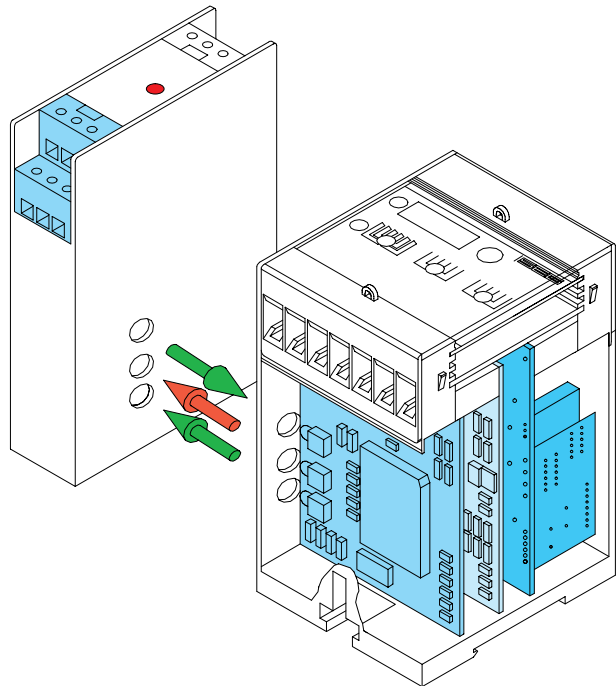

Fig. 4.5: Communication principle

For communication of the units among with a superior management system, the interface adapter *XRS1* is available for data transmission, including operating software for our relays. This adapter can easily be retrofitted at the side of the relay. Screw terminals simplify its installation. Optical transmission of this adapter makes galvanic isolation of the relay possible. Aided by the software, actual measured values can be processed, relay parameters set and protection functions programmed at the output relays. Information about unit *XRS1* in detail can be taken from the description of this unit.

5. Relay case and technical data

5.1 Relay case

Relay **XG2** is designed to be fastened onto a DIN-rail acc. to DIN EN 50022, the same as all units of the *PROFESSIONAL LINE*.

The front plate of the relay is protected with a sealable transparent cover (IP40).

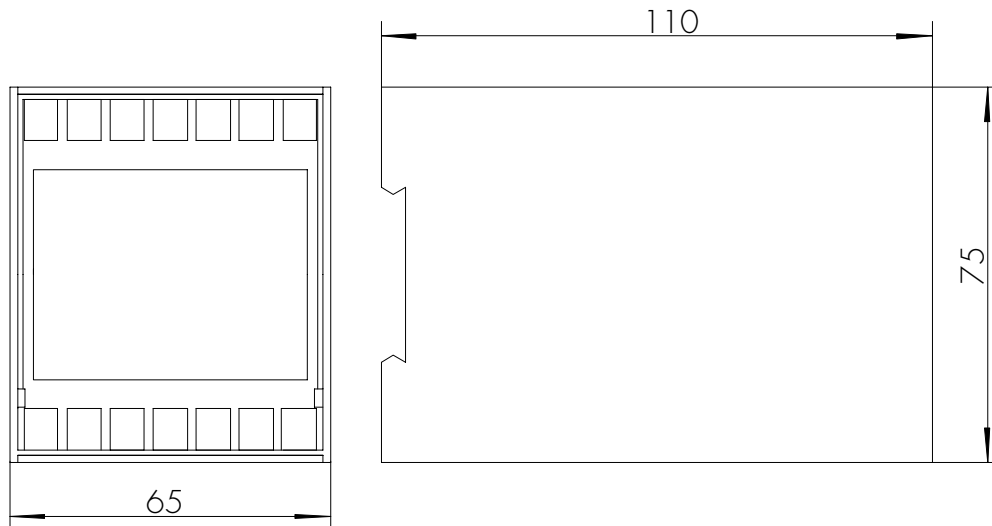

Fig. 5.1: Dimensional drawings

Connection terminals

The connection of up to a maximum of 2 x 2.5 mm² cross-section conductors is possible. For this the transparent cover of the unit has to be removed (see para. 4).

5.2 Technical Data

Connection possibilities:

System voltage	Setting Un	Connection	Setting	Connection	Setting	Connection	Setting
100 / 58 V	100 V	58 V single-phase	Y	100 V 3-phase	Δ	100/58 V four wire	Y
110 / 63 V	110 V	63 V single-phase	Y	110 V 3-phase	Δ	110/63 V four wire	Y
230 / 130 V	230 V	130 V single-phase	Y	230 V 3-phase	Δ	230/130 V four wire	Y
400 / 230 V	400 V	230 V single-phase	Y	400 V 3-phase	Δ	400/230 V four wire	Y
690 / 400 V		not possible		not possible		not possible	

Table 5.1: Connection possibilities

Measuring input circuits

Rated data

Rated voltage Un:

100, 110, 230, 400 V AC (phase-to-phase voltage)

Rated frequency range:

35 - 78 Hz (35 - 66 Hz at communication via serial interface)

Power consumption
at the voltage circuit: 1 VA/per phase at U_n

Thermal carrying capacity
of the voltage circuit: continuously 520 V AC

Auxiliary voltage

Rated auxiliary voltage U_v /: 36 - 520 V AC ($f = 35 - 78$ Hz) or 50 - 750 V DC /
4 W (terminals A1-A3)

Power consumption: 19 - 55 V DC / 3 W (terminals A1(L-) and A2(L+))

Common data

Dropout to pickup ratio: depending on the adjusted hysteresis

Resetting time from pickup: <50 ms

Returning time from trip: 500 ms

Minimum initialization time
after supply voltage has applied: 100 ms

Minimum response time
when supply voltage is available: 70 ms

Output relay

Number of relays: 2

Contacts: 1 changeover contact for each trip relay

Maximum breaking capacity: ohmic 1250 VA/AC or 120 W/DC

inductive 500 VA/AC or 75 W/DC

Max. rated voltage: 250 V AC

220 V DC ohmic load $I_{max.} = 0,2$ A

inductive load $I_{max.} = 0,1$ A at $L/R \leq 50$ ms

24 V DC inductive load $I_{max.} = 5$ A

Minimum load: 1 W / 1 VA at $U_{min} \geq 10$ V

Max. rated current: 5 A

Making current (16 ms): 20 A

Contact life span: 10^5 operations at max. breaking capacity

System data

Design standards:	VDE 0435 T303; IEC 0801 part 1-4, VDE 0160; IEC 255-4; BS 142 VDE 0871
Temperature range at storage and operation:	-25°C to +70°C
Climatic resistance class F acc. to DIN 40040 and DIN IEC 68, T.2-3:	more than 56 days at 40°C and 95 % relative humidity
High voltage test acc. to VDE 0435, part 303	
Voltage test:	2.5 kV (eff.), 50 Hz - 1 min
Surge voltage test:	5 kV, 1.25/50 μ s, 0.5 J
High frequency test:	2.5 kV/1MHz
Electrostatic discharge (ESD) acc. to IEC 0801 part 2:	8 kV
Radiated electro-magnetic field test acc. to IEC 0801 part 3:	10 V/m
Electrical fast transient (burst) acc. to IEC 0801 part 4:	4 kV / 2.5 kHz, 15 ms
Radio interference suppression test acc. to DIN 57871 and VDE 0871:	limit value class A
Repeat accuracy:	0.2°
Rated values:	0.4°
Frequency effect:	0.2° for the whole frequency range
Mechanical test	
Shock:	class 1 acc. to DIN IEC 255-21-2
Vibration:	class 1 acc. to DIN IEC 255-21-1
Degree of protection	
Front plate:	IP40 when the front cover is closed
Weight:	approx. 0.5 kg
Mounting position:	any
Relay case material:	self-extinguishing
GL-Approbation:	94658-94HH

Parameter	Setting range	Graduation
$\Delta\theta$	1 - 31°	1°
$U_{B<}$	20 - 70 % U_n	continuously variable

Table 5.1: Setting ranges and graduation

Technical data subject to change without notice!

Setting-list XG2

Project: _____ SEG job.-no.: _____

Function group: = _____ Location: + _____ Relay code: - _____

Relay functions: _____ Date: _____

Setting of parameters

Function		Unit	Default settings	Actual settings
$\Delta\theta$	Vector surge setting	°	1°	
$U_{B<}$	Blocking voltage	% Un	20%	

DIP-switch	Function	Default settings	Actual settings
1*	Adjustment of rated voltage	100 V	
2*		100 V	
3*		100 V	
4	Phase sequence supervision	inactive	
5	Single phase / three phase measuring	single phase	
6			
7			
8			

*Only one of the DIP-switches 1 - 3 shall be in „ON“-position at the same time.



Schaltanlagen-Elektronik-Geräte GmbH & Co. KG

Abteilung Gerätevertrieb / Electronic Devices Sales Department

Krefelder Weg 47 · D - 47906 Kempen (Germany)

Postfach 10 07 67 (P.O.B.) · D - 47884 Kempen (Germany)

Tel.: +49 (0)21 52 1 45-1 · Fax.: +49 (0)21 52 1 45-3 54

e-mail: electronics@avkseg.com