

MRI3-IHE - Time overcurrent relay with evaluation of the 2nd harmonic and earth current measuring

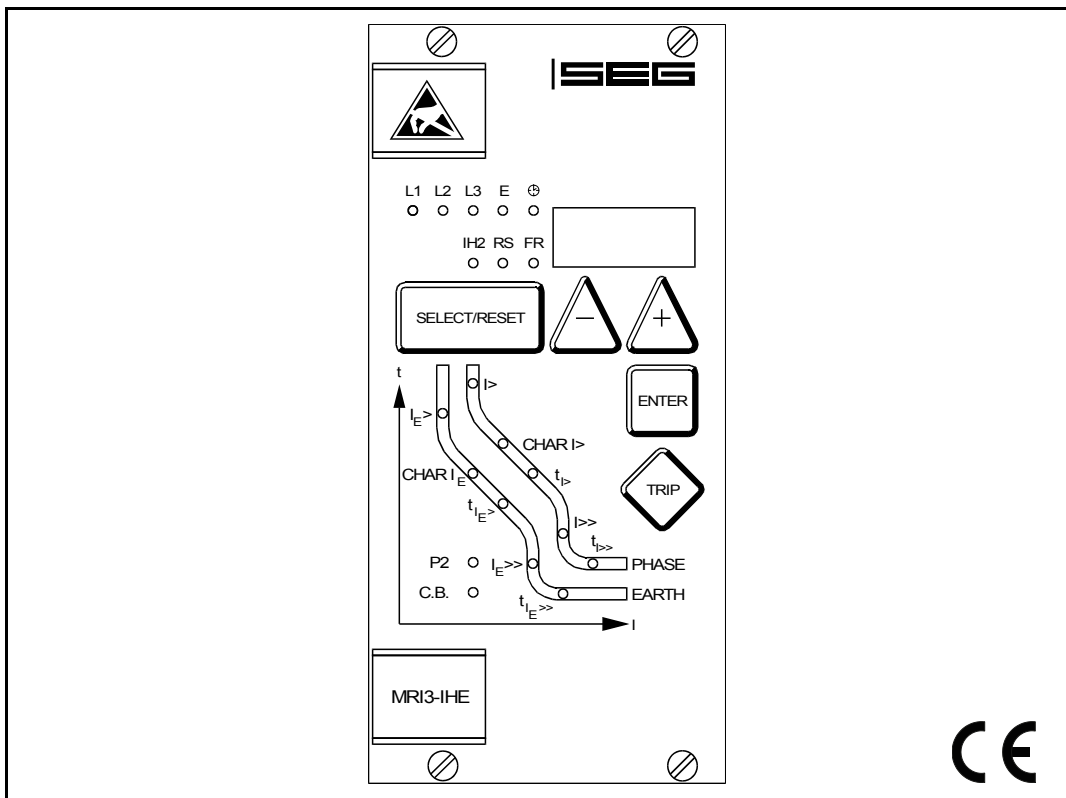

Contents

1 Introduction and Application

2 Features and characteristics

3 Design

- 3.1 Connections
 - 3.1.1 Analog input circuits
 - 3.1.2 Output relays
 - 3.1.3 Blocking input
 - 3.1.4 External reset input
 - 3.1.5 Fault recorder
- 3.2 Front plate

4 Working principle

- 4.1 Analog circuits
- 4.2 Digital circuits
- 4.3 Recognition of the 2nd harmonic
- 4.4 Demand imposed on the main current transformers

5 Operation and settings

- 5.1 Display
- 5.2 Setting procedure
- 5.3 System parameter
 - 5.3.1 Display of measuring values as primary quantities (I_{prim} phase)
 - 5.3.2 Display of earth current as primary quantity (I_{prim} earth)
 - 5.3.3 Nominal frequency
 - 5.3.4 Display of the activation storage (FLSH/NOFL)
 - 5.3.5 Parameterswitch/external triggering of the fault recorder
- 5.4 Protection parameters
 - 5.4.1 Switch-over value for detection of the 2nd harmonic (IH2)
 - 5.4.2 Pickup current for phase overcurrent element ($I_{>}$)
 - 5.4.3 Tripping value for the phase overcurrent stage ($I_{>IH2}$)
 - 5.4.4 Time current characteristics for phase overcurrent element (CHAR $I_{>}$)
 - 5.4.5 Trip delay or time multiplier for phase overcurrent element ($t_{>}$)
 - 5.4.6 Reset setting in the phase current path
 - 5.4.7 Current setting for high set element ($I_{>>}$)
 - 5.4.8 Tripping value for phase short-circuit fast tripping ($I_{>>IH2}$)
 - 5.4.9 Trip delay for high set element ($t_{>>}$)
 - 5.4.10 Pickup current for earth fault element ($I_{E>}$)
 - 5.4.11 WARN/TRIP changeover
 - 5.4.12 Time current characteristics for earth fault element (CHAR I_E)
 - 5.4.13 Trip delay or time multiplier for earth fault element ($t_{E>}$)
 - 5.4.14 Resetting time for inverse time earth fault element (not ER-relay type)

- 5.4.15 Current setting for high set element of earth fault supervision ($I_{E>>}$)
- 5.4.16 Trip delay for high set element of earth fault supervision ($t_{E>>}$)
- 5.4.17 Block/Trip time
- 5.4.18 Circuit breaker failure protection t_{CBFP}
- 5.4.19 Adjustment of the slave address
- 5.4.20 Setting of Baud-rate (applies for Modbus Protocol only)
- 5.4.21 Setting of parity (applies for Modbus Protocol only)
- 5.5 Fault recorder
 - 5.5.1 Adjustment of the fault recorder
 - 5.5.2 Number of the fault recordings
 - 5.5.3 Adjustment of trigger occurrences
 - 5.5.4 Pre-trigger time (T_{pre})
- 5.6 Adjustment of the clock
- 5.7 Additional functions
 - 5.7.1 Blocking of the protective functions and assignment of the output relays
- 5.8 Indication of measuring and fault values
 - 5.8.1 Indication of measuring values
 - 5.8.2 Unit of the measuring values displayed
 - 5.8.3 Indication of fault data
 - 5.8.4 Fault memory
- 5.9 Reset
 - 5.9.1 Erasure of fault storage

6 Relay testing and commissioning

- 6.1 Power-On
- 6.2 Testing the output relays and LEDs
- 6.3 Checking the set values
- 6.4 Secondary injection test
 - 6.4.1 Test equipment
 - 6.4.2 Example of test circuit for MRI3-IHE
 - 6.4.3 Testing the input circuits and Checking the measured values
 - 6.4.4 Checking the operating and resetting values of the relay
 - 6.4.5 Checking the relay operating time
 - 6.4.6 Checking the high set element of the relay
 - 6.4.7 Checking the external blocking and reset functions
 - 6.4.8 Testing the external blocking with Block/Trip function
 - 6.4.9 Test of the CB failure protection
- 6.5 Primary injection test
- 6.6 Maintenance

7 Technical data

- 7.1 Measuring circuits
- 7.2 Common data
- 7.3 Setting ranges and steps
 - 7.3.1 Systemparameter
 - 7.3.2 Protection parameter - time overcurrent protection
 - 7.3.3 Earth fault protection
 - 7.3.4 Block/Trip - time
 - 7.3.5 Circuit breaker failure protection
 - 7.3.6 Interface parameter
 - 7.3.7 Parameter for the fault recorder
 - 7.3.8 Inverse time overcurrent protection relay
- 7.4 Tripping characteristics
- 7.5 Output relays

8 Order form

1 Introduction and Application

The digital multifunctional relay *MRI3-IHE* has been designed as a universal time overcurrent protection relay with evaluation of the 2nd harmonic for transformers.

The relay gives a complete thermal characteristic of the electrical equipment to be protected taking into account its initial load.

The *MRI3-IHE* furthermore provides a universal time overcurrent and earth fault protection with the following functions:

It is equipped with the following functions:

- Two-step overload protection with evaluation of the 2nd harmonic
- Display of the measured values for 1st and 2nd harmonic
- independent (Definite) time overcurrent relay.
- inverse time overcurrent relay with selectable characteristics,
- two-element (low and high set) earth fault protection with definite or inverse time characteristics.

2 Features and characteristics

- Microprocessor technology with self-supervision,
- measuring of phase current as RMS value,
- digital filtering of the measured values by using discrete Fourier analysis to suppress the high frequency harmonics and DC components induced by faults or system operations (earth current only),
- two parameter sets,
- selectable protective functions between:
 - definite time overcurrent relay and
 - inverse time overcurrent relay,
- selectable inverse time characteristics according to IEC 255-4:
 - Normal Inverse (Type A)
 - Very Inverse (Type B)
 - Extremely Inverse (Type C)
 - Special characteristics,
- Reset mode for all characteristics selectable,
- high set overcurrent element with instantaneous trip,
- two-element (inverse time and definite time) overcurrent relay both for phase and earth faults,
- Display of measuring values as primary quantities,
- measuring of phase current of the short circuit breaker operation,
- blocking of high set element (e.g. for selective fault detection through minor overcurrent protection units after unsuccessful AR),
- the protective functions can be freely assigned to the output relays (assignment matrix),
- withdrawable modules with automatic short circuiters of C.T. inputs when modules are withdrawn,
- storage of trip values and switching-off time (t_{CBFP}) of 5 fault occurrences (fail-safe of voltage),
- recording of up to eight fault occurrences with time stamp,
- switch failure protection,
- serial data exchange via RS485 interface possible; alternatively with SEG RS485 Pro-Open Data Protocol or Modbus Protocol,
- Display of date and time.

Important:

For additional common data of all *MR*-relays please refer to manual „*MR*-Digital Multifunctional relays“.

3 Design

3.1 Connections

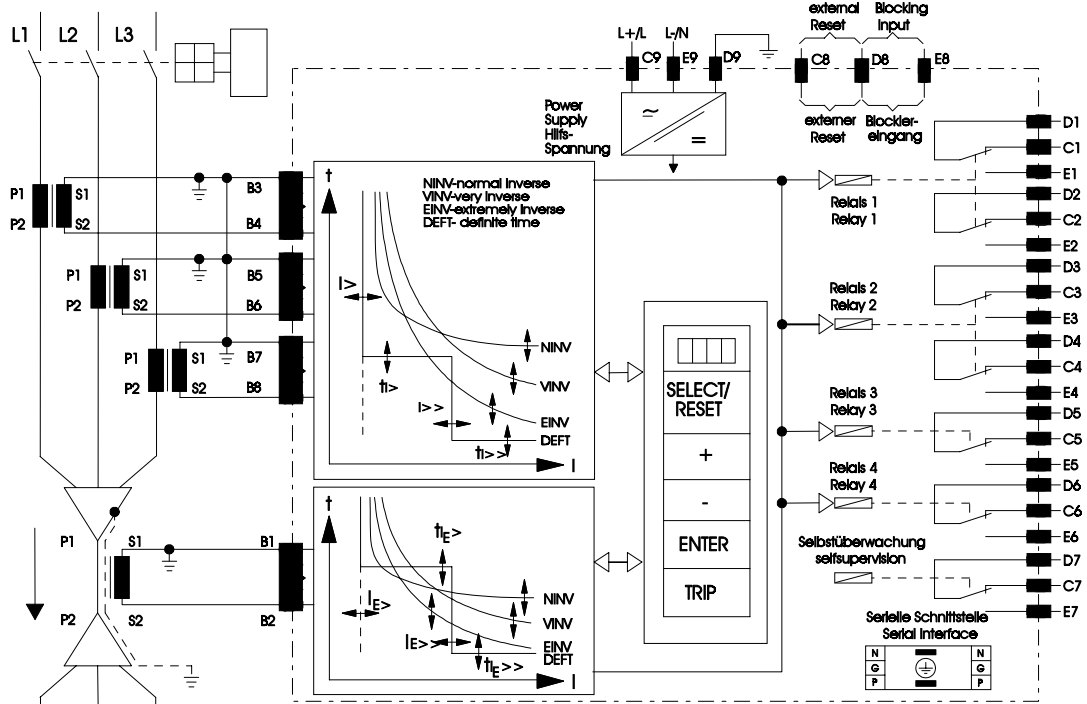

Figure 3.1: Connection diagram

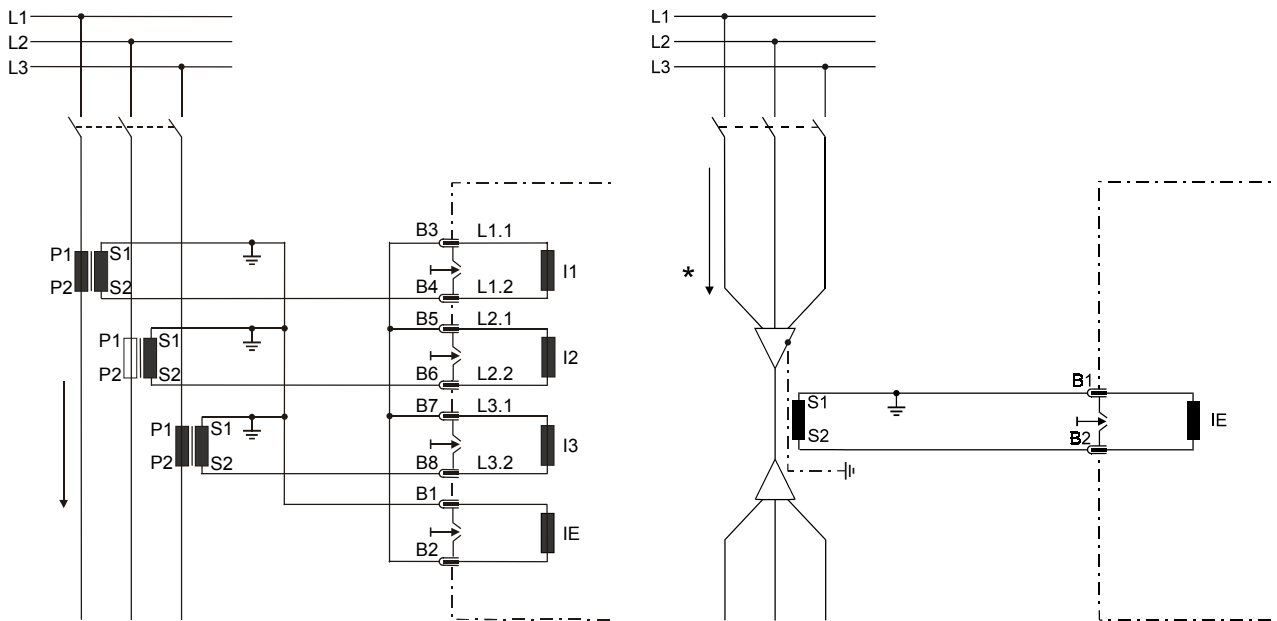

Figure 3.2: Phase current measuring and earth-current detection by means of Holmgreen-circuit.

Figure 3.3: Earth-fault measuring by means of ring-core C.T. (I_E)

This connection can be used with three existing phase current transformers when combined phase and earth-current measuring is required.

When phase- and earth-fault current measuring are combined, the connection has to be realized as per Figure 3.2 and Figure 3.3.

3.1.1 Analog input circuits

The protection unit receives the analog input signals of the phase currents I_{L1} (B3-B4), I_{L2} (B5-B6), I_{L3} (B7-B8) and the residual current I_E (B1-B2) each via separate input transformers.

The constantly detected current measuring values are galvanically decoupled, filtered and finally fed to the analog/digital converter.

3.1.2 Output relays

Two relays are equipped with two change-over contacts and three relays with each one change-over contact for alarm. Apart from the relay for self-supervision, all protective functions can be optionally assigned:

- Relay 1: C1, D1, E1 and C2, D2, E2
- Relay 2: C3, D3, E3 and C4, D4, E4
- Relay 3: C5, D5, E5
- Relay 4: C6, D6, E6
- Relay 5: Self-supervision C7, D7, E7

All trip and alarm relays are working current relays, the relay for self supervision is an idle current relay.

3.1.3 Blocking input

The function for blocking can be parameterized arbitrary. When an auxiliary voltage is connected to D8/E8 those relay functions will be blocked which were parameterized before (see chapter 5.7.1).

3.1.4 External reset input

See chapter 5.9

3.1.5 Fault recorder

The *MRI3-IHE* is equipped with a disturbance value recorder which records the measured analogue values as momentary values. The momentary values

$$i_{L1}, i_{L2}, i_{L3}, i_E$$

are scanned within a grid 1.25 ms (with 50 Hz) or 1.041 ms (with 60 Hz) and filed in a circulating storage. The max. storage capacity amounts to 16 s (with 50 Hz) or 13.33 s (with 60 Hz).

Storage division

Independent of the recording time, the entire storage capacity can be divided into several cases of disturbance with a shorter recording time each. In addition, the deletion behaviour of the fault recorder can be influenced.

No writing over

If 2, 4 or 8 recordings are chosen, the complete memory is divided into the relevant number of partial segments. If this max. number of fault event has been exceeded, the fault recorder block any further recordings in order to prevent that the stored data are written over. After the data have been read and deleted, the recorder to ready again for further action.

Writing over

If 1, 3 or 7 recordings are chosen, the relevant number of partial segments is reserved in the complete memory. If the memory is full, a new recording will always write over the oldest one.

The memory part of the fault recorder is designed as circulating storage. In this example 7 fault records can be stored (written over).

Memory space 8 to 4 is occupied.

Memory space 5 is currently being written in

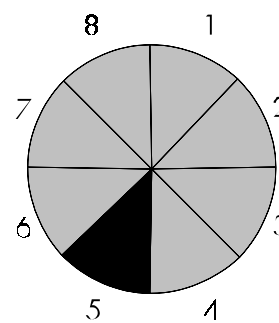

Figure 3.4: Division of the memory into 8 segments, for example

Since memory spaces 6, 7 and 8 are occupied, this example shows that the memory has been assigned more than eight recordings. This means that No. 6 is the oldest fault recording and No. 4 the most recent one.

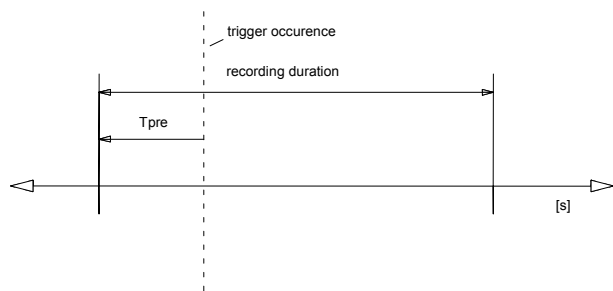

Figure 3.5: Basic setup of the fault recorder

Each memory segment has a specified storage time which permits setting of a time prior to the trigger event.

Via the interface RS485 the data can be read and processed by means of a PC with HTL/PL-Soft4. The data is graphically edited and displayed. Binary tracks are recorded as well, e.g. activation and trip.

3.2 Front plate

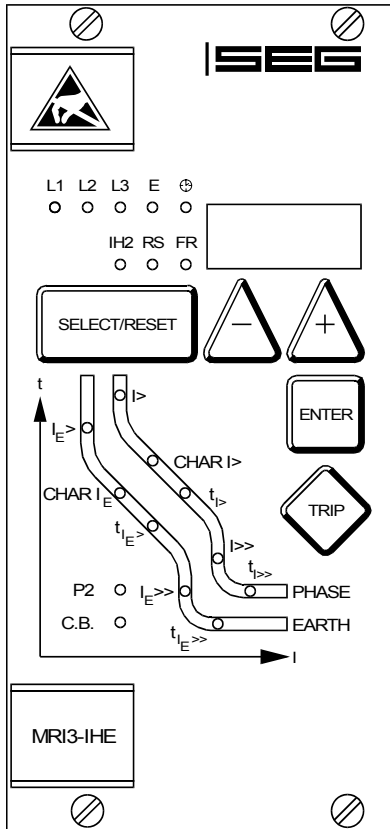

Figure 3.6: Front plate MRI3-IHE

The LEDs to the left of the display in the top row are two-coloured; green for measurements and red for fault signals. In the row below only the LED IH2 emits light in two colours.

While the slave address of the serial interface is being adjusted, the LED marked RS is alight.

The LED FR is alight while the parameters for the fault recorder are being set.

The light-emitting diodes arranged in the characteristic segment support comfortable menu guidance. They are located in prominent places of the adjustment curves. 5 LEDs for the overcurrent/short-circuit path as well as 5 LEDs in the earth current path in conjunction with the display always indicate the selected menu point.

The LED P2 indicates which parameter set is active at the moment. The CB display is alight while the CB failure protection is being adjusted.

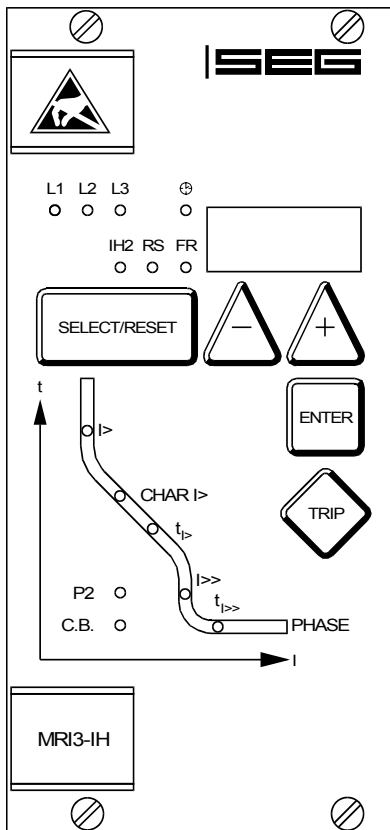

Figure 3.7: Front plate MRI3-IH

4 Working principle

4.1 Analog circuits

The incoming currents from the main current transformers on the protected object are converted to voltage signals in proportion to the currents via the input transformers and burden. The noise signals caused by inductive and capacitive coupling are suppressed by an analog RC filter circuit.

The analog voltage signals are fed to the A/D-converter of the microprocessor and transformed to digital signals through Sample and Hold circuits. The analog signals are sampled at 50 Hz (60 Hz) with a sampling frequency of 800 Hz (960 Hz), namely, a sampling rate of 1.25 ms (1.04 ms) for every measuring quantity.

4.2 Digital circuits

The essential part of the *MRI3-IHE* relay is a powerful microcontroller. All of the operations, from the analog digital conversion to the relay trip decision, are carried out by the microcontroller digitally. The relay program is located in an EPROM (Electrically-Programmable-Read-Only-Memory). With this program the CPU of the microcontroller calculates the three phase in order to detect a possible fault situation in the protected object.

For the calculation of the current value an efficient digital filter based on the Fourier Transformation (DFFT - Discrete Fast Fourier Transformation) is applied to suppress high frequency harmonics and DC components caused by fault-induced transients or other system disturbances. The calculated actual current values are compared with the relay settings.

In case, the time for which a current was above the preset pickup value, exceeds the trip delay or the thermal capacity is reached, an alarm signal will be given. Dependent on their adjustment the output relays will also be activated.

The relay setting values for all parameters are stored in a parameter memory (EEPROM - Electrically Erasable Programmable Read-only Memory), so that the actual relay settings cannot be lost, even if the power supply is interrupted. The microprocessor is supervised by a built-in "watchdog" timer. In case of a failure the watchdog timer resets the microprocessor and gives an alarm signal, via the output relay "self supervision".

4.3 Recognition of the 2nd harmonic

The overcurrent time relay *MRI3-IHE* is a combination of an overcurrent time relay (base unit *MRI3*) with an additional recognition of the second harmonic.

This supervision unit influences the tripping times of the overcurrent and/or short-circuit stage by switching over between two switching points. During normal operation (with minimum share of the 2nd harmonic) the *MRI3-IHE* works like a normal overcurrent time relay with pre-selected UMZ or AMZ tripping characteristic and set tripping value $I_>$.

The following diagram explains switching-over to a different $I_>$ value. $I_>$ is the tripping value during normal operation and $I_>IH2$ if the share of the second harmonic exceeds the tripping value.

Switch-over if $I_{H2} >$ on $I_>IH2$

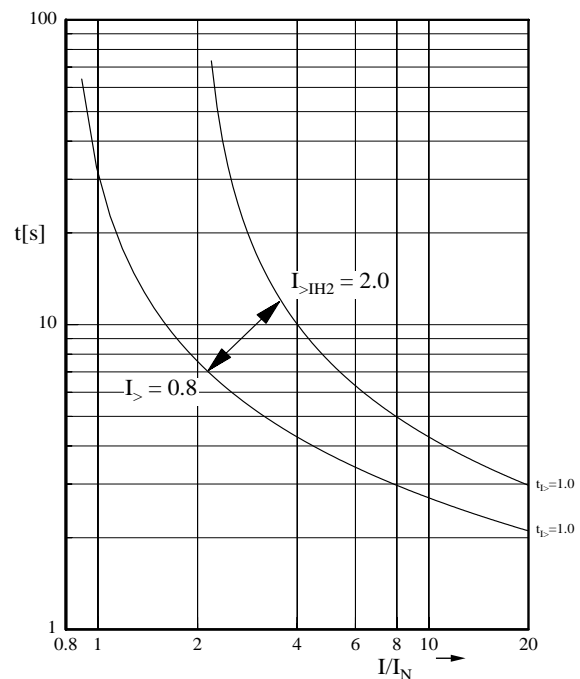

Example: $I_> = 0.8$; $I_>IH2 = 2.0$

The criterion used for stabilising against faulty tripping of transformers during a switch-on process is the existing 2nd harmonic of the current. The *MRI3-IH2* recognises this and switches over to the higher tripping value $I_>IH2$ without delay. This prevents faulty tripping. But the trip protection for faults possibly occurring during the switch-on process will be maintained.

4.4 Demand imposed on the main current transformers

The current transformers have to be rated in such a way, that a saturation should not occur within the following operating current ranges:

Independent time overcurrent function: $K1 = 2$
Inverse time overcurrent function: $K1 = 20$
High-set function: $K1 = 1.2 - 1.5$
 $K1 =$ Current factor related to set value

Moreover, the current transformers have to be rated according to the maximum expected short circuit current in the network or in the protected objects. The low power consumption in the current circuit of *MRI3-IHE*, namely $<0,2$ VA, has a positive effect on the selection of current transformers. It implies that, if an electromechanical relay is replaced by *MRI3-IHE*, a high accuracy limit factor is automatically obtained by using the same current transformer.

5 Operation and settings

5.1 Display

Function	Display shows	Pressed pushbutton	Corresponding LED
Normal operation	SEG		
Measured operating values	actual measured values, related to I_{Nv} , Temperature equivalent in %	<SELECT/RESET> one time for each value	L1, L2, L3, E
Display of the second rated repetition current	SEC 0.002-50.0 kA=prim	<+> <-><SELECT/RESET>	L1, L2, L3, E
Rated frequency	f = 50 / f = 60	<+> <-><SELECT/RESET>	
LED-blinking after activation	FLSH/NOFL	<+> <-><SELECT/RESET>	
Parameter switch	SET1; SET2; B_S2; R_S2; B_FR; R_FR; S2_FR	<+> <-><SELECT/RESET>	P2
Blocking of function	EXIT	<+> until max. setting value	LED of blocked parameter
Characteristics	DEFT, NINV, VINV, EINV, LONG, RINV, RXIDG	<+> <-><SELECT/RESET>	CHAR l> CHAR IE>
Switch failure protection	CBFP	after tripping	C. B.
Recorded fault data	Phase currents, earth cur- rents and temperature equivalent	<SELECT/RESET> one time for each phase	L1, L2, L3, E
Enquiry failure memory	FLT1, FLT2.....	<+> <-><SELECT/RESET>	L1, L2, L3, E l>, l>>, l<sub>E>, l<sub>E>>
Delete failure memory	wait	<+> <-><SELECT/RESET>	
Relay trip	TRIP	<TRIP> or after fault tripping	
Secret password input	„XXXX“	<+><-> <ENTER> <SELECT/RESET>	
System reset	SEG	<SELECT/RESET> for about 3 s	
Manual trip	TRI?	<TRIP> three times	
Inquire password	PSW?	<TRIP><ENTER>	
Blocking of protection function	BLOC, NO_B	<ENTER> und <TRIP>	
Switching over the blocking function	PR_B; TR_B	<+> <-><SELECT/RESET>	l>; l>>; l<sub>E>; l<sub>E>>; t<sub>B>; t<sub>B>>; t<sub>E>; t<sub>E>>
Relay assignment	e. g. _ 2 _ _	<ENTER> and <TRIP>	
Trigger signal for the fault recorder	P_UP; A_PI; TRIP; TEST	<+> <-><SELECT/RESET>	FR
Number of fault occurrences	S = 2, S = 4, S = 8	<+> <-><SELECT/RESET>	FR
Display of date and time	Y = 99, M = 10, D = 1, h = 12, m = 2, s = 12	<+> <-><SELECT/RESET>	⊕
Slave address of serial interface	1-32	<+> <-><SELECT/RESET>	RS
Baud-Rate ¹⁾	1200-9600	<SELECT/RESET> <+><->	RS
Parity-Check ¹⁾	even odd no	<SELECT/RESET> <+><->	RS
Setting values: Currents and time delays	Current and time settings	<SELECT/RESET> one time for each parameter	l>; CHAR l>; t<sub>B>; l>>; t<sub>B>>; l<sub>E>; CHAR l<sub>E>; t<sub>E>; l<sub>E>>; t<sub>E>>
Save parameter?	SAV?	<ENTER>	
Save parameter!	SAV!	<ENTER> for about 3 s	
Display of software-version	First part (e.g. D21-) Second part (e.g. 1.00)	<TRIP> one time for each part	

Table 5.1: possible indication messages on the display

¹⁾ only Modbus

5.2 Setting procedure

After push button <SELECT/RESET> has been pressed, always the next measuring value is indicated. Firstly the operating measuring values are indicated and then the setting parameters. By pressing the <ENTER> push button the setting values can directly be called up and changed. Before parameter setting can be started the relevant password must be entered (refer to Chapter 4.4 of the "MR Digital Multifunctional Relay" Description).

5.3 System parameter

5.3.1 Display of measuring values as primary quantities (I_{prim} phase)

With this parameter it is possible to show the indication as primary measuring value. For this purpose the parameter must be set to be equal with the rated primary CT current. If the parameter is set to "sec", the measuring value is shown as a multiple of the rated secondary CT current.

Example:

The current transformer used is of 1500/5 A. The flowing current is 1380 A. The parameter is set to 1500 A and on the display "1380 A" are shown. If the parameter is set to "sec", the value shown on the display is "0.92" x I_n .

Note:

The pick-up value is set to a multiple of the rated secondary CT current.

5.3.2 Display of earth current as primary quantity (I_{prim} earth)

The parameter of this function is to be set in the same way as that described under 5.3.1.

5.3.3 Nominal frequency

The adapted FFT-algorithm requires the nominal frequency as a parameter for correct digital sampling and filtering of the input currents.

By pressing <SELECT> the display shows "f=50" or "f=60". The desired nominal frequency can be adjusted by <+> or <-> and then stored with <ENTER>.

5.3.4 Display of the activation storage (FLSH/NOFL)

If after an activation the existing current drops again below the pickup value, e.g. I_p , without a trip has been initiated, LED I_p signals that an activation has occurred by flashing fast. The LED keeps flashing until it is reset again (push button <RESET>). Flashing can be suppressed when the parameter is set to NOFL.

5.3.5 Parameterswitch/ external triggering of the fault recorder

By means of the parameter-change-over switches it is possible to activate two different parameter sets. Switching over of the parameter sets can either be done by means of software or via the external inputs RESET or blocking input. Alternatively, the external inputs can be used for Reset or blocking of the triggering of the fault recorder.

Software-parameter	Blocking input used as	RESET Input use as
SET1	Blocking input	RESET Input
SET2	Blocking input	RESET Input
B_S2	Parameter switch	RESET Input
R_S2	Blocking input	Parameter switch
B_FR	Ext. triggering of the FR	Reset input
R_FR	Blocking input	Ext. Trigger for FR
S2_FR	Parameter switch	Ext. Trigger for FR

With the settings SET1 or SET2 the parameter set is activated by software. Terminals C8/D8 and D8/E8 are then available as external reset input or blocking input.

With the setting B_S2 the blocking input (D8, E8) is used as parameter-set change-over switch. With the setting R_S2 the reset input (D8, E8) is used as parameter-set change-over switch. With the setting B_FR the fault recorder is activated immediately by using the blocking input. On the front plate the LED FR will then light up for the duration of the recording. With the setting R_FR the fault recorder is activated via the reset input. With the setting S2_FR parameter set 2 can be activated via the blocking input and/or the fault recorder via the reset input.

The relevant function is then activated by applying the auxiliary voltage to one of the external inputs.

Important note:

The relevant parameter-set change-over switch or the external RESET or blocking input used for external triggering is not available then. If, for example, the external blocking input is used as parameter-set change-over switch, the protection functions must be separately blocked by means of software (for this refer to chapter 5.7.1)

5.4 Protection parameters

5.4.1 Switch-over value for detection of the 2nd harmonic (IH2)

This parameter indicates as from which size of the 2nd harmonic there should be a switch-over to a higher switching point. The setting is effected as a multiple value of the device current. The displayed value can be changed by means of the keys <+> and <->. The required value is then stored by means of the <SELECT/RESET> key.

5.4.2 Pickup current for phase overcurrent element (I>)

When the tripping value for the phase overcurrent stage I> is being adjusted, the display shows a value with reference to the secondary rated current. This means:

Tripping value (I_s) = displayed value x rated current (I_N).

For example, if displayed value = 1.25, I_s = 1.25 x I_N

5.4.3 Tripping value for the phase overcurrent stage (I>IH2)

Depending on the detection of the 2nd harmonic, this parameter I>IH2 becomes active. It is adjusted the same way as described in chapter 5.4.4. The displayed value cannot be set smaller than the parameter I> for the overcurrent I>.

5.4.4 Time current characteristics for phase overcurrent element (CHAR I>)

By setting this parameter, one of the following 6 messages appears on the display:

DEFT	-	Definite time (Type A)
NINV	-	Normal inverse (Type B)
VINV	-	Very inverse (Type C)
EINV	-	Extremely inverse
RINV	-	RI-inverse
LINV	-	Long Time Inverse

Anyone of these four characteristics can be chosen by using <+> <->-pushbuttons, and can be stored by using <ENTER>-pushbutton.

5.4.5 Trip delay or time multiplier for phase overcurrent element (t_r)

Usually, after the characteristic is changed, the time delay or the time multiplier should be changed accordingly. In order to avoid an unsuitable arrangement of relay modes due to carelessness of the operator, the following precautions are taken:

After the characteristic setting, the setting process turns to the time delay setting automatically. The LED tI> is going to flash yellow to remind the operator to change the time delay setting accordingly. After pressing the <SELECT>-pushbutton, the present time delay setting value is shown on the display. The new setting value can then be changed by using <+> <-> -pushbuttons.

If, through a new setting, another relay characteristic other than the old one has been chosen (e.g. from DEFT to NINV), but the time delay setting has not been changed despite the warning from the flashing LED, the relay will be set to the most sensitive time setting value of the selected characteristics after five minutes warning of flashing LED tI>. The most sensitive time setting value means the fastest tripping for the selected relay characteristic. When the time delay or the time multiplier is set out of range (Text "EXIT" appears on the display), the low set element of the overcurrent relay is blocked. The "WARN"-relay will not be blocked.

5.4.6 Reset setting in the phase current path

To ensure tripping, even with recurring fault pulses shorter than the set trip delay, the reset mode for inverse time tripping characteristics can be switched over. If the adjustment tRST is set at 60 s, the tripping time is only reset after 60 s faultless condition. This function is not available if tRST is set to 0. With fault current cease the trip delay is reset immediately and started again at recurring fault current.

5.4.7 Current setting for high set element (I>>)

The current setting value of this parameter appearing on the display is related to the nominal current of the relay

This means: I>> = displayed value \times I_N.

When the current setting for high set element is set out of range (on display appears "EXIT"), the overcurrent high set element is blocked.

5.4.8 Tripping value for phase short-circuit fast tripping (I>>IH2)

Adjustment is made as described in chapter 5.4.9. The adjustment value cannot be set smaller than the parameter for short-circuit fast tripping I>.

5.4.9 Trip delay for high set element (t_{r>>})

Independent from the chosen tripping characteristic for I>, the high set element I>> has always a definite-time tripping characteristic. An indication value in seconds appears on the display.

5.4.10 Pickup current for earth fault element (I_{E>})

(Similar to 5.4.2)

5.4.11 WARN/TRIP changeover

An earth fault can be parameterized as follows:

- "warn" only the alarm relay trips
- "TRIP" the trip relay trips and tripping values are stored.

5.4.12 Time current characteristics for earth fault element (CHAR I_E)

By setting this parameter, one of the following 7 messages appears on the display:

DEFT	-	Definite Time (independent overcurrent time protection)
NINV	-	Normal inverse (Type A)
VINV	-	Very inverse (Type B)
EINV	-	Extremely inverse (Type C)
RINV		RI-Inverse
LINV		Long Time Inverse
RXID		Special characteristic

Anyone of these four characteristics can be chosen by using <+> <->-pushbuttons, and can be stored by using <ENTER>-pushbutton.

5.4.13 Trip delay or time multiplier for earth fault element (t_{IE})

(Similar to 5.4.5)

5.4.14 Resetting time for inverse time earth fault element (not ER-relay type)

(Similar to 5.4.6)

5.4.15 Current setting for high set element of earth fault supervision (I_{E>})

(Similar to 5.4.7)

5.4.16 Trip delay for high set element of earth fault supervision (t_{IE>})

(Similar to 5.4.9)

5.4.17 Block/Trip time

The block/trip time serves for detection of a c.b. failure protection by rear interlocking. It is activated by setting the blocking input D8/E8 and by setting the parameter to TR_B. After the set block/trip time has expired, the relay can be tripped if the excitation of a protective function has been applied the delay time of which has expired and the blocking function is still active. If the parameter PR_B is set, the individual protection stages are blocked (refer to Chapter 5.7.1).

5.4.18 Circuit breaker failure protection

t_{CBFP}

The CB failure protection is based on supervision of phase currents during tripping events. Only after tripping this protective function becomes active. The test criterion is whether all phase currents are dropped to $<1\% \times I_N$ within t_{CBFP} (Circuit Breaker Failure Protection - adjustable between 0.1 - 2.0 s). If not all of the phase currents have dropped to $<1\% \times I_N$ within this time, CB failure is detected and the related relay activated. The CB failure protection function is deactivated again as soon as the phase currents have dropped to $<1\% \times I_N$ within t_{CBFP}.

5.4.19 Adjustment of the slave address

Pressing pushbuttons <+> and <-> the slave address can be set in range of 1-32.

5.4.20 Setting of Baud-rate (applies for Modbus Protocol only)

Different transmission rates (Baud rate) can be set for data transmission via Modbus Protocol.

The rate can be changed by push buttons <+> and <-> and saved by pressing <ENTER>.

5.4.21 Setting of parity (applies for Modbus Protocol only)

The following three parity settings are possible :

- "even" = even
- "odd" = odd
- "no" = no parity check

The setting can be changed by push buttons <+> and <-> and saved by pressing <ENTER>.

5.5 Fault recorder

5.5.1 Adjustment of the fault recorder

The *MRI3-IHE* is equipped with a fault recorder (see chapter 3.1.5). Three parameters can be determined.

5.5.2 Number of the fault recordings

The max. recording time is 16 s at 50 Hz or 13.33 s at 60 Hz.

The number of max. recordings requested has to be determined in advance. There is a choice of (1)* 2, (3)* 4 or (7)* 8 recordings and dependent on this the duration of the individual fault recordings is defined, i.e.

(1)* 2 recordings for a duration of 8 s (with 50 Hz)
(6.66 s with 60 Hz)

(3)* 4 recordings for a duration of 4 s (with 50 Hz)
(3.33 s with 60 Hz)

(7)* 8 recordings for a duration of 2 s (with 50 Hz)
(1.66 s with 60 Hz)

* is written over when a new trigger signal arrives

5.5.3 Adjustment of trigger occurrences

There is a choice between four different occurrences:

P_UP (PickUP)	Storage is initiated after recognition of a general activation
TRIP	Storage is initiated after a trip has occurred
A_PI (After Pickup)	Storage is initiated after the last activation threshold was fallen short of.
TEST	Storing is activated by simultaneous actuation of the keys <+> and <->. During the recording time the display shows "Test".

5.5.4 Pre-trigger time (T_{pre})

By the time T_{pre} it is determined which period of time prior to the trigger occurrence should be stored as well. It is possible to adjust a time between 0.05 s and 8 s. With keys <+> and <-> the values can be changed and with <ENTER> be saved.

5.6 Adjustment of the clock

When adjusting the date and time, LED ☺ lights up. The adjustment method is as follows:

Date:	Year	Y=00
	Month	M=00
	Day	D=00

Time:	Hour	h=00
	Minute	m=00
	Second	s=00

The clock starts with the set date and time as soon as the supply voltage is switched on. The time is safeguarded against short-term voltage failures (min. 6 minutes).

Note:

The window for parameter setting is located behind the measured value display. The parameter window can be accessed via the <SELECT/RESET> key.

5.7 Additional functions

5.7.1 Blocking of the protective functions and assignment of the output relays

Blocking of the protective functions:

The *MRI3-IHE* is equipped with a blocking function that can be parameterized arbitrary. Connecting supply voltage to terminals D8/E8 blocking of those functions which were selected by the user takes place.

It is possible to choose between two types of protective blocking:

1. Blocking of the individual protection stages. The excitation of the blocked protection stage is blocked..
2. Blocking of the individual tripping stages. The individual protection stages are excited and the set tripping time expires. Tripping only takes place when:
 - a) the voltage at the blocking input D8/E8 is reduced;
 - b) the voltage at the blocking input D8/E8 is applied, the tripping time and the blocking time have expired. (refer to Chapter 5.4.17)

Parameter setting is to be carried out as follows:

- After the <ENTER> and <TRIP> keys have been actuated simultaneously, the display shows the text "PR_B" (the protection stages are blocked) or "TR_B" (the tripping stages are blocked).
- The settings can be changed by actuating the keys <+> or <->. In this procedure, the LEDs I>; I>>; IE>; IE>> are simultaneously alight in case of protective blocking "PR_B" and LEDs tI>; tI>>; tIE>; tIE>> simultaneously emit light in case of trip blocking "TR_B".
- Actuation of the <ENTER> key with a one-time entry of the password will store the set function.
- After this actuate the <SELECT/RESET> key to call up the first blockable protection function.
- The display will show the text "BLOC" (the respective function is blocked) or "NO_B" (the respective function is not blocked).
- Actuation of the <ENTER> key will store the set function.
- By pressing the <SELECT/RESET> pushbutton, all further protective function that can be blocked are called one after the other.
- After selection of the last blocking function renewed pressing of the <SELECT/RESET> pushbutton switches to the assignment mode of the output relays.

Function		Display	LED/Colour
Blocking of the protection stage		PR_B	I>; I>>; IE>; IE>>
Blocking of the trip function		TR_B	tI>; tI>>; tIE>; tIE>>
I>	Overcurrent	NO_B	I> red
I> IH2	Overcurrent 2 nd Harmonic	NO_B	I> yellow + IH2 green
I>>	Short circuit	BLOC	I>> red
I>> IH2	Short circuit 2 nd Harmonic	BLOC	I>> yellow + IH2 green
IE>	Earth current 1 st element	NO_B	IE> red
IE>>	Earth current 2 nd element	NO_B	IE>> red
t _{CBFP}	Circuit breaker failure protection	NO_B	CB green

Table 5.4: Defaults settings of blocking functions

Assignment to the output relays:

Unit *MRI3-IHE* has five output relays. The fifth output relay is provided as permanent alarm relay for self supervision is normally on. Output relays 1 - 4 are normally off and can be assigned as alarm or tripping relays to the frequency functions which can either be done by using the pushbuttons on the front plate or via serial interface RS485. The assignment of the output relays is similar to the setting of parameters, however, only in the assignment mode. The assignment mode follows the blocking mode.

The relays are assigned as follows:

The LEDs of protection stages I>; I>>; IE>; IE>> will emit light if the output relays are assigned as alarm relays. If the output relays are assigned as tripping relays, the LEDs tI>; tI>>; tIE> and tIE>> will light up.

Definition:

Alarm relays are activated at pickup of the relay.

Tripping relays are only activated after elapse of the tripping delay.

After the assignment mode has been selected, LED IH2 emits a green light. The stage for detection of the 2nd harmonic can now be assigned one or more of the four output relays. At the same time, the display shows the selected relays. The display "1 _ _ _" indicates that the output relay is assigned to this function. If the display shows "_ _ _ _", no relay is assigned to this stage. The assignment of the output relays 1 – 4 can be changed by using the keys <+> or <->. The chosen assignment can be stored by pressing <ENTER> and then entering the password.

The assignment of output relays 1 - 4 to the current elements can be changed by pressing <+> and <-> push buttons. The selected assignment can be stored by pressing push button <ENTER> and subsequent input of the password. By pressing push button <SELECT/RESET>, LED I> lights up red. The output relays can now be assigned to this current element as tripping relays.

Relays 1-4 for the other elements are selected in the same way as described before. The assignment mode can be terminated at any time by pressing the <SELECT> pushbutton for some time (abt. 3 s).

Note:

- The function of jumper J2 described in general description "MR Digital Multifunctional Relays" has no function. For relays without assignment mode this jumper is used for parameter setting of alarm relays (activation at pickup or tripping).

A form is attached to this description where the setting requested by the customer can be filled-in.

Relay function	Output relays				Display-indication	Corresponding LED
	1	2	3	4		
IH2> Alarm		X			_ 2 _ _	IH2: green
I> Alarm		X			_ 2 _ _	I>; yellow
tI> Trip	X				1 _ _ _	tI>; yellow
I>> Alarm			X		_ _ 3 _	I>>; yellow
tI>> Trip					1 _ _ _	tI>>; yellow
IE> Alarm				X	_ _ _ 4	IE>; yellow
tIE> Trip	X				1 _ _ _	tIE>; yellow
IE> Alarm				X	_ _ _ 4	IE>; yellow
tIE> Trip	X				1 _ _ _	tIE>; yellow
tCBFP Trip					_ _ _ _	C.B. red

Table 5.1: Example of assignment matrix of the output relays (default settings)

5.8 Indication of measuring and fault values

5.8.1 Indication of measuring values

The following measuring quantities can be indicated on the display during normal service:

- Current in phase 1 (LED L1 green), first harmonic
- Current in phase 1 (LED L1 and IH2 green), 2nd harmonic
- Current in phase 2 (LED L2 green), first harmonic
- Current in phase 2 (LED L2 and IH2 green), 2nd harmonic
- Current in phase 3 (LED L3 green), first harmonic
- Current in phase 3 (LED L3 and IH3 green), 2nd harmonic
- Earth current (LED E green)
- Date and time (LED ⌚ green)

5.8.2 Unit of the measuring values displayed

The measuring values can optionally be shown in the display as a multiple of the "sec" rated value (xIn) or as primary current (A). According to this the units of the display change as follows:

Phase current

Indication as	Range	Unit
Secondary current	.000 – 40.0	x In
Primary current	.000 – 999.	A
	k000 – k999	kA*
	1k00 – 9k99	kA
	10k0 – 99k0	kA
	100k – 999k	kA
	1M00 – 2M00	MA

Earth current

Indication as	Range	Unit
Secondary current	.000 – 15.0	x In
Primary earth current	.000 – 999.	A
	k000 – k999	kA*
	1k00 – 9k99	kA
	10k0 – 99k0	kA
	100k – 999k	kA
	1M00 – 2M00	MA

* Display shows at 2kA primary current

5.8.3 Indication of fault data

All faults detected by the relay are indicated on the front plate optically. For this purpose, the four LEDs (L1, L2, L3, E) and the four function LEDs (I>, I>>, IE> und IE>>) are equipped at **MR13-IHE**. If, for example an overcurrent occurs, first the jeweiligen Phasen will light up. LED I> lights up at the same time. After tripping the LEDs are lit permanently.

5.8.4 Fault memory

When the relay is energized or trips, all fault data and times are stored in a non-volatile memory manner. The **MR13-IHE** is provided with a fault value recorder for max. five fault occurrences. In the event of additional trippings always the oldest data set is written over.

For fault indication not only the trip values are recorded but also the status of LEDs. Fault values are indicated when push buttons <-> or <+> are pressed during normal measuring value indication.

- Normal measuring values are selected by pressing the <SELECT/RESET> button.
- When then the <-> button is pressed, the latest fault data set is shown. By repeated pressing the <-> button the last but one fault data set is shown etc. For indication of fault data sets abbreviations FLT1, FLT2, FLT3, ... are displayed (FLT1 means the latest fault data set recorded). At the same time the parameter set active at the occurrence is shown.
- By pressing <SELECT/RESET> the fault measuring values can be scrolled.
- By pressing <+> it can be scrolled back to a more recent fault data set. At first FLT8, FLT7, ... are always displayed. When fault recording is indicated (FLT1 etc), the LEDs flash in compliance with the stored trip information, i.e. those LEDs which showed a continuous light when the fault occurred are now blinking to indicate that it is not a current fault. LEDs which were blinking during trip conditions, (element had picked up) just briefly flash.
- If the relay is still in trip condition and not yet reset (TRIP is still displayed), no measuring values can be shown.
- To delete the trip store, the push button combination <SELECT/RESET> and <-> has to be pressed for about 3s. The display shows "wait".

5.9 Reset

Unit *MRI3-IHE* has the following three possibilities to reset the display of the unit as well as the output relay at jumper position J3=ON.

Manual Reset

- Pressing the pushbutton <SELECT/RESET> for some time (about 3 s)

Electrical Reset

- Through applying auxiliary voltage to C8/D8

Software Reset

- The software reset has the same effect as the <SELECT/RESET> pushbutton (see also communication protocol of RS485 interface).

The display can only be reset when the pickup is not present anymore (otherwise "TRIP" remains in display).

During resetting of the display the parameters are not affected.

5.9.1 Erasure of fault storage

The fault storage is erased by pressing the key combination <SELECT/RESET> and <-> for about 3 s. At the display "Wait" appears.

6 Relay testing and commissioning

The test instructions following below help to verify the protection relay performance before or during commissioning of the protection system. To avoid a relay damage and to ensure a correct relay operation, be sure that:

- The auxiliary power supply rating corresponds to the auxiliary voltage on site.
- The rated current of the relay corresponds to the plant data on site.
- The current transformers are connected to the relay correctly.
- All signal circuits and output relay circuits are connected correctly.

6.1 Power-On

Note!

Prior to switch on the auxiliary power supply, be sure that the auxiliary supply voltage corresponds with the rated data on the type plate.

Switch on the auxiliary power supply to the relay and check that the message "ISEG" appears on the display and the self supervision alarm relay (watchdog) is energized (Contact terminals D7 and E7 closed).

6.2 Testing the output relays and LEDs

NOTE!

Prior to commencing this test, interrupt the trip circuit to the circuit breaker if tripping is not desired. By pressing the pushbutton <TRIP> once, the display shows the first part of the software version of the relay (e.g. „D38-“). By pressing the pushbutton <TRIP> twice, the display shows the second part of the software version of the relay (e.g. „1.00“). The software version should be quoted in all correspondence. Pressing the <TRIP> button once more, the display shows "PSW?". Please enter the correct password to proceed with the test. The message "TRI?" will follow. Confirm this message by pressing the pushbutton <TRIP> again. All output relays and LEDs should then be activated and the self supervision alarm relay (watchdog) be deactivated one after another with a time interval of 3 seconds. Thereafter, reset all output relays back to their normal positions by pressing the pushbutton <SELECT/RESET> (about 3 s).

6.3 Checking the set values

By repeatedly pressing the pushbutton <SELECT>, all relay set values may be checked. Set value modification can be done with the pushbutton <+><-> and <ENTER>. For detailed information about that, please refer to chapter 5.

For a correct relay operation, be sure that the frequency set value ($f=50/60$) has been selected according to your system frequency (50 or 60 Hz).

6.4 Secondary injection test

6.4.1 Test equipment

- Ammeter with class 1 or better,
- auxiliary power supply with the voltage corresponding to the rated data on the type plate,
- single-phase current supply unit (adjustable from 0 to $\geq 4 \times I_N$ und 50 – 120 Hz),
- timer to measure the operating time (Accuracy class $\leq \pm 10$ ms),
- switching device and
- test leads and tools

6.4.2 Example of test circuit for MRI3-IHE

Testing of the *MRI3-IHE* relay requires the connection of a power source the frequency of which can be controlled and/or switched over. Fig. 6.1 shows a simple example of a single-phase test circuit with controllable power source for testing the relay.

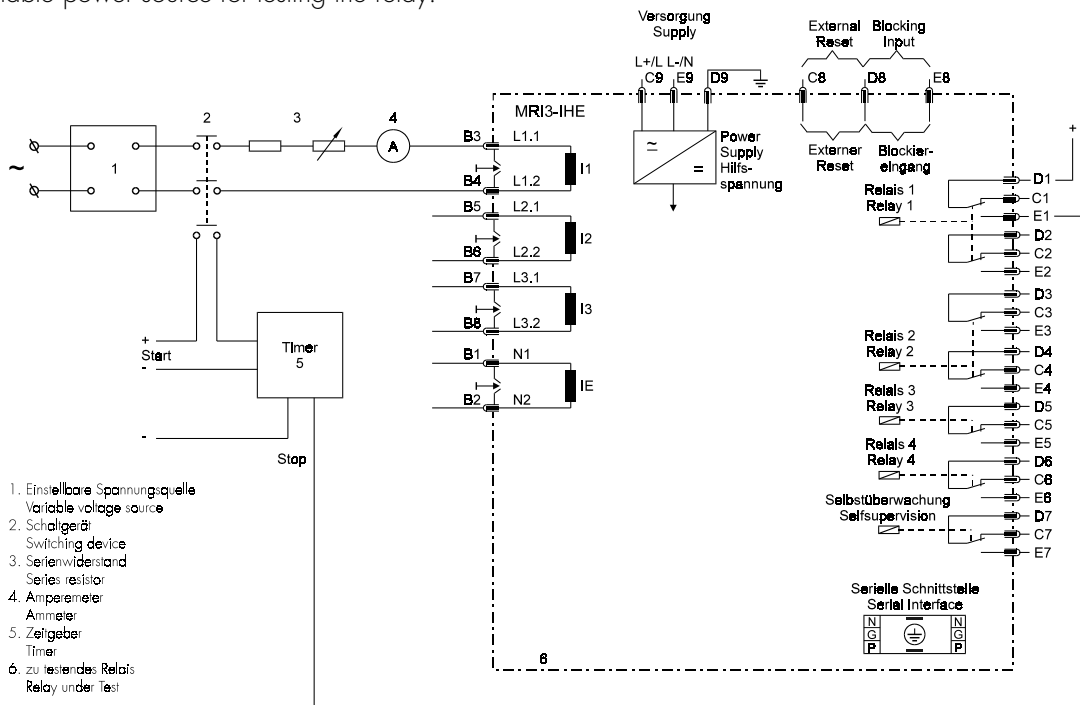

Figure 6.1: Test circuit

6.4.3 Testing the input circuits and Checking the measured values

For the purpose of checking the measured values, a current smaller than the set tripping current of the *MRI3-IHE* must be impressed on phase 1 (terminals B3 – B4) with rated frequency. If the <SELECT> key is pressed the display will show the momentary measured value for the first harmonic, which can be tested with an ammeter. If the <SELECT> key is pressed again, the measured value for the 2nd harmonic will be displayed. This measuring value should show "0.00" on the display. If the current is impressed on phase 1 with double frequency, the display should show approximately the same value as the measuring instrument.

Example: With an *MRI3-IHE* with $I_N = 5A$ a current with a rated frequency amounting to 1A is to be impressed. The value shown on the display should be 0.2 ($0.20 \times I_N$) for the first harmonic and approximately "0.00" $\times I_N$ for the 2nd harmonic. If the frequency for the impressed current of 1A is doubled, the display will show "0.00" $\times I_N$ for the first harmonic and "0.00" I_N for the 2nd harmonic.

This applies for the setting $I_{prim} = "sec."$ (refer to Chapter 5.3.1). In the event that the display shows primary measuring values, the parameter I_{prim} can be set to "0.005" kA; the display then shows "5.00" A.

The current can be also injected into the other current input circuits (Phase 2: terminals B5-B6, Phase 3: terminals B7-B8, Earth current: terminals B1-B2) in the same manner. Compare the displayed current value with the reading of the ammeter. The deviation must not exceed 33%.

General hint: When checking the individual tripping functions, it would be advisable to release only those parameters which shall be tested. Set parameters to „EXIT“, since otherwise there might be tripping of several protective functions. Attention must also be paid to the fact that - for this protective function - the „correct“ output relay will be assigned.

Example: The tripping value of the phase overcurrent is to be tested and the test circuit's structure is the same as above. In this case, in the assignment mode, relay 1 is assigned to the function $t_{>}$.

6.4.4 Checking the operating and resetting values of the relay

Inject a current which is less than the relay set values in phase 1 of the relay and gradually increase the current until the relay starts, i.e. at the moment when the LED I> and L1 light up or the alarm output relay I> is activated. Read the operating current indicated by the ammeter. The deviation must not exceed 5% of the set operating value.

Furthermore, gradually decrease the current until the relay resets, i.e. the alarm output relay I> is disengaged. Check that the resetting current is not smaller than 0.97 times the operating current.

Repeat the test on phase 2, phase 3 and earth current input circuits in the same manner.

6.4.5 Checking the relay operating time

To check the relay operating time, a timer must be connected to the trip output relay contact. The timer should be started simultaneously with the current injection in the current input circuit and stopped by the trip relay contact. Set the current to a value corresponding to twice the operating value and inject the current instantaneously. The operating time measured by the timer should have a deviation of less than 3% of the set value or <20 ms.

Repeat the test on the other phases or with the inverse time characteristics in the similar manner.

In case of inverse time characteristics the injected current should be selected according to the characteristic curve, e.g. two times I_s . The tripping time may be read from the characteristic curve diagram or calculated with the equations given under "technical data".

Please observe that during the secondary injection test the test current must be very stable. Otherwise the test results may be wrong. This especially applies for currents smaller than $2 \times I_s$, where the trip delays are in the steep range of the inverse curves.

6.4.6 Checking the high set element of the relay

Set a current above the set operating value of I>>. Inject the current instantaneously and check that the alarm output relay I>> operates. Check the tripping time of the high set element according chapter 6.4.5. Check the accuracy of the operating current setting by gradually increasing the injected current until the I>> element picks up. Read the current value from the ammeter and compare with the desired setting. Repeat the entire test on other phases and earth current input circuits in the same manner.

Note !

Where test currents $>4 \times I_N$ are used, the thermal withstand capability of the current paths has to be considered (see technical data, chapter 7.1)

6.4.7 Checking the external blocking and reset functions

By means of the external blocking input, it is possible to block all protective functions. To give an example, the blocking function of the phase current high set element is described.

This can be tested by first setting the parameter for the phase current high set element to „BLOC“ and then connecting the auxiliary voltage to terminals E8/D8. The phase current low set element I> should be set to EXIT for this test. Inject a test current which could cause a high set (I>>) tripping. Observe that there is no trip of any assigned output relay of the high set or low set element.

Remove the auxiliary supply voltage from the blocking input. Inject a test current to trip the relay (message „TRIP“ on the display). Interrupt the test current and apply auxiliary supply voltage to the external reset input of the relay (terminals C8/D8). The display and LED indications should be reset immediately.

6.4.8 Testing the external blocking with Block/Trip function

In order to simplify things, the short-circuit stage is to be tested here as described in Chapter 6.4.7. For this purpose, the parameter for the Block/Trip function must be set to "TR_B" (first value in the blocking menu of the protection functions Chapter 5.7.1. The appertaining Block/Trip time should be longer than the set tripping time $t_{I>>}$ (see chapter 5.4.17). Here, too, a current is impressed which should make the short-circuit stage trip. After the Block/Trip time has expired, tripping will take place. Tripping takes place when:

- the blocking input has been set
- a tripping stage has been excited
- the appertaining tripping time has expired
- the Block/trip time has expired

If the Block/Trip time is set shorter than the tripping time, tripping will only take place after the tripping time has expired.

6.4.9 Test of the CB failure protection

For testing the tripping time a test current of about 2 times the rated current to be injected. The timer is started upon tripping of the relay of a protection function ($I>$, $I>>$, $I_E>$, $I_E>>$) and stopped as soon as the relay for the CB failure protection has picked up. Message "CBFP" is displayed. The tripping time ascertained by the timer should not deviate more than 1% or, at short trip delay, less than ± 10 ms from the set tripping time.

Alternatively, the timer can be started when the aux. voltage and the test current are injected simultaneously. The timer stops when the corresponding output relay for circuit breaker failure protection trips. In this case the previously measured tripping delay has to be subtracted from the total tripping time measured.

6.5 Primary injection test

Generally, a primary injection test could be carried out in the similar manner as the secondary injection test described above. With the difference that the protected power system should be, in this case, connected to the installed relays under test „on line“, and the test currents and voltages should be injected to the relay through the current and voltage transformers with the primary side energized. Since the cost and potential hazards are very high for such a test, primary injection tests are usually limited to very important protective relays in the power system.

Because of its powerful combined indicating and measuring functions, the *MRI3-IHE* relay may be tested in the manner of a primary injection test without extra expenditure and time consumption.

In actual service, for example, the measured current values on the *MRI3-IHE* relay display may be compared phase by phase with the current indications of the ammeter of the switchboard to verify that the relay works and measures correctly.

6.6 Maintenance

Maintenance testing is generally done on site at regular intervals. These intervals vary among users depending on many factors: e.g. the type of protective relays employed; the importance of the primary equipment being protected; the user's past experience with the relay, etc.

For electromechanical or static relays, maintenance testing will be performed at least once a year according to the experiences. For digital relays like *MRI3-IHE*, this interval can be substantially longer. This is because:

- The *MRI3-IHE* relays are equipped with very wide self-supervision functions, so that many faults in the relay can be detected and signaled during service. Important: The self-supervision output relay must be connected to a central alarm panel!
- The combined measuring functions of *MRI3-IHE* relays enable supervision the relay functions during service.
- The combined TRIP test function of the *MRI3-IHE* relay allows to test the relay output circuits.

A testing interval of two years for maintenance will, therefore, be recommended.

During a maintenance test, the relay functions including the operating values and relay tripping characteristics as well as the operating times should be tested.

7 Technical data

7.1 Measuring circuits

Rated data:	Nominal current I_N Nominal frequency f_N	1 A or 5 A 50/60 Hz adjustable
Power consumption in current circuit:	at $I_N = 1$ A at $I_N = 5$ A	0.2 VA 0.1 VA
Power consumption in voltage circuit:		<1 VA
Thermal withstand capability in current circuit:	dynamic current withstand (half-wave) for 1 s for 10 s continuously	$250 \times I_N$ $100 \times I_N$ $30 \times I_N$ $4 \times I_N$
Thermal withstand capability in voltage circuit:	continuously	$1.5 \times U_N$

7.2 Common data

Dropout to pickup ratio:	>97%
Returning time:	30 ms
Time lag error class index E:	± 10 ms
Minimum operating time:	60 ms
Transient overreach at instantaneous operation:	$\leq 5\%$
Permissible interruption of the supply voltage without influence on the function:	50 ms

Influences on the current measurement

Auxiliary voltage:	In the range $0.8 < U_H / U_{HN} < 1.2$ no additional influences can be measured.
Frequency:	in the range $0.9 < f / f_N < 1.1$; $< 0.2\%$ / Hz
Harmonics:	up to 20% of the third harmonic; $< 0.08\%$ per percent of the third harmonic up to 20% of the fifth harmonic; $< 0.07\%$ per percent of the fifth harmonic
Influences on delay times:	No additional influences can be measured.
GL-Approbation:	98775-96 HH
Bureau Veritas Approbation:	2650 6807 A00H

For further technical data please refer to manual „MR-Multifunctional relays“.

7.3 Setting ranges and steps

7.3.1 Systemparameter

	Setting range	Step	Tolerance
$I_{prim L1 L2 L3 E}$	(SEK) 0.002... 50.0 kA	0.001 kA (0.002...0.200) 0.002 kA (0.200...0.500) 0.005 kA (0.500... 1.00) 0.01 kA (1.00...2.00) 0.02 kA (2.00...5.00) 0.05 kA (5.00...10.0) 0.1 kA (10.0...20.0) 0.2 kA (20.0...50.0)	
f_N	50/60 Hz		

7.3.2 Protection parameter – time overcurrent protection

	Setting range	Step	Tolerance
I _{H2}	0.2...4.0 x I _N (EXIT)	0.01 (0.2...0.5) 0.02 (0.5...1.0) 0.05 (1.0...2.0) 0.1 (2.0...4.0)	±5% from set value or min. ±2% I _N
I _{>}	0.2...4.0 x I _N (EXIT)	0.01 (0.2...0.5) 0.02 (0.5...1.0) 0.05 (1.0...2.0) 0.1 (2.0...4.0)	±3% from set value or min. ±2% I _N
I _{>} I _{H2} *	0.2...4.0 x I _N (EXIT)	0.01 (0.2...0.5) 0.02 (0.5...1.0) 0.05 (1.0...2.0) 0.1 (2.0...4.0)	±3% from set value
t _{>}	0.04 - 260 s (EXIT) (definite time) 0.05 - 20 (EXIT) (inverse time)	0.02 (0.04...1.0) 0.05 (1.0...2.0) 0.1 (2.0...5.0) 0.2 (5.0...8.5) 0.5 (8.5...10.0) 1.0 (10...20) 2.0 (20...50) 5.0 (50...100) 10.0 (100...260) 0.01 (0.05...0.5) 0.02 (0.5...1.0) 0.05 (1.0...2.0) 0.1 (2.0...5.0) 0.2 (5.0...10.0) 0.5 (10.0...20.0)	±3% or ±20 ms ±5% for NINV and VINV ±7,5% for NINV and EINV
I _{>>}	0.5...40 x I _N (EXIT)	0.05 (1.0...2.0) 0.1 (2.0...4.0) 0.2 (4.0...10.0) 0.5 (10.0...20.0) 1.0 (20.0...40.0)	±3% from set value
I _{>>} I _{H2} *	1...40 x I _N (EXIT)	0.05 (1.0...2.0) 0.1 (2.0...4.0) 0.2 (4.0...10.0) 0.5 (10.0...20.0) 1.0 (20.0...40.0)	±5% from set value or min. ±2% I _N
t _{>>}	0.04...10 s (EXIT)	0.02 (0.04...1.0) 0.05 (1.0...2.0) 0.1 (2.0...5.0) 0.2 (5.0...10.0)	±3% or ±20 ms

*Valu cannot be set smaller than I_> or I_{>>}

Table 7.1: Setting values and steps

7.3.3 Earth fault protection

	Setting range	Step	Tolerance
$I_{E>}$	0.01...2.0 x I_N (EXIT)	0.01 (0.2...0.5) 0.02 (0.5...1.0) 0.05 (1.0...2.0)	±3% from set value or ±0.3% I_N
$t_{E>}$	0.04 - 260 s (EXIT) (definite time) 0.05 - 20 (EXIT) (inverse time)	0.02 (0.04...1.0) 0.05 (1.0...2.0) 0.1 (2.0...5.0) 0.2 (5.0...8.5) 0.5 (8.5...10.0) 1.0 (10...20) 2.0 (20...50) 5.0 (50...100) 10.0 (100...260) 0.01 (0.05...0.5) 0.02 (0.5...1.0) 0.05 (1.0...2.0) 0.1 (2.0...5.0) 0.2 (5.0...10.0) 0.5 (10.0...20.0)	±3% or ±20 ms ±5% for NINV and VINV ±7.5% for NINV and EINV
$I_{E>>}$	0.01...1.5 x I_N (EXIT)	0.01 (0.2...0.5) 0.02 (0.5...1.0) 0.05 (1.0...2.0)	±3% from set value
$t_{E>>}$	0.04...10 s (EXIT)	0.02 (0.06...0.5) 0.05 (0.5...2.0) 0.1 (2.0...5.0) 0.2 (5.0...10)	±3% or ±20 ms
f_N	50 / 60 Hz		
RS		1...32	

Table 7.1: Setting ranges and steps

7.3.4 Block/Trip - time

$t_{\text{BLOCK/TRIP}}$	0.1...2.0 s; EXIT	0.01; 0.02; 0.05; 0.1 s	$\pm 1\%$ bzw. ± 10 ms
-------------------------	-------------------	-------------------------	----------------------------

7.3.5 Circuit breaker failure protection

t_{CBFP}	t_{CBFP}	0.1...2.0 s; EXIT	0.01; 0.02; 0.05; 0.1 s	$\pm 1\%$ bzw. ± 10 ms
-------------------	-------------------	-------------------	-------------------------	----------------------------

7.3.6 Interface parameter

Function	Parameter	Modbus-Protocol	RS485 Open Data Protocol
RS	Slave-Address	1 - 32	1 - 32
RS	Baud-Rate*	1200, 2400, 4800, 9600	9600 (fixed)
RS	Parity*	even, odd, no	"even Parity" (fixed)

*only Modbus Protocol

7.3.7 Parameter for the fault recorder

Function	Parameter	Adjustment example
FR	Number of recordings	(1)* 2 x 8 s; (3)* 4 x 4 s; (7)* 8 x 2 s (with 50 Hz) (1)* 2 x 6.66 s, (3)* 4 x 3.33 s, (7)* 8 x 1.66 s (60 Hz)
FR	Saving of the recording at the occurrence	P_UP; TRIP; A_PI; TEST
FR	Pre-trigger-time	0.05 s – 8.00 s

* is written over when a new trigger signal arrives

7.3.8 Inverse time overcurrent protection relay

According to IEC 255-4 or BS 142

Normal Inverse (type A)
$$t = \frac{0,14}{\left(\frac{I}{I_s}\right)^{0,02} - 1} t_1 > [s]$$

Very Inverse (type B)
$$t = \frac{13,5}{\left(\frac{I}{I_s}\right) - 1} t_1 > [s]$$

Extremely Inverse (type C)
$$t = \frac{80}{\left(\frac{I}{I_s}\right)^2 - 1} t_1 > [s]$$

Long time inverse
$$t = \frac{120}{\left(\frac{I}{I_s}\right) - 1} t_1 > [s]$$

RInverse
$$t = \frac{1}{0,339 - \frac{0,236}{\left(\frac{I}{I_s}\right)}} t_1 > [s]$$

*RXIDG – characteristic
$$t = 5,8 - 1,3 * \left[\ln \cdot \left(\frac{I}{I_s} \right) \right] \cdot t_1 > [s]$$

Where:

t = tripping time
 $t_1 >$ = time multiplier
 I = fault current
 I_s = Starting current
 I_N = natural logarithm

*only for earth current

7.4 Tripping characteristics

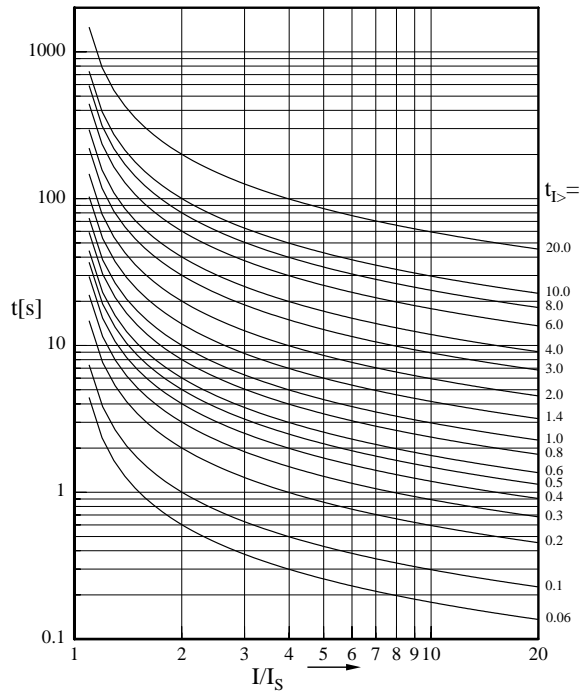

Figure 7.1: Normal Inverse

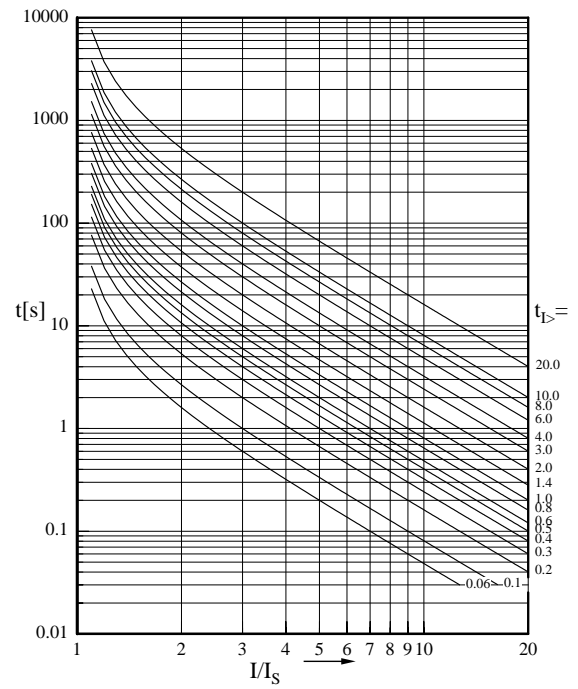

Figure 7.3: Extremely Inverse

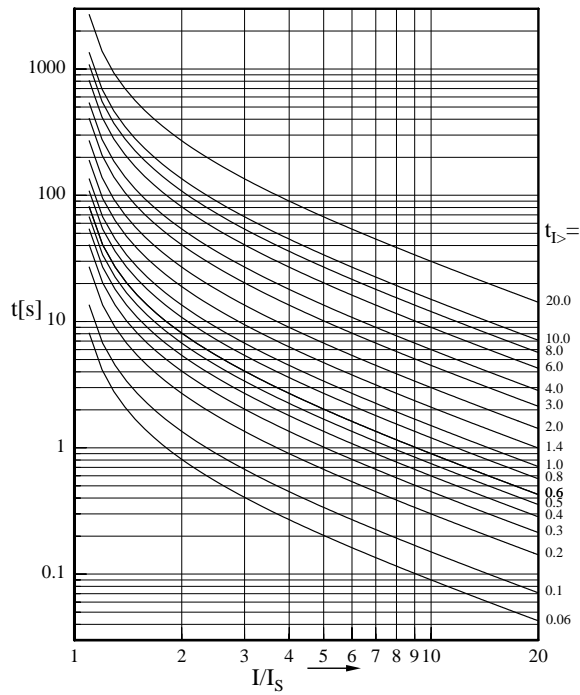

Figure 7.2: Very Inverse

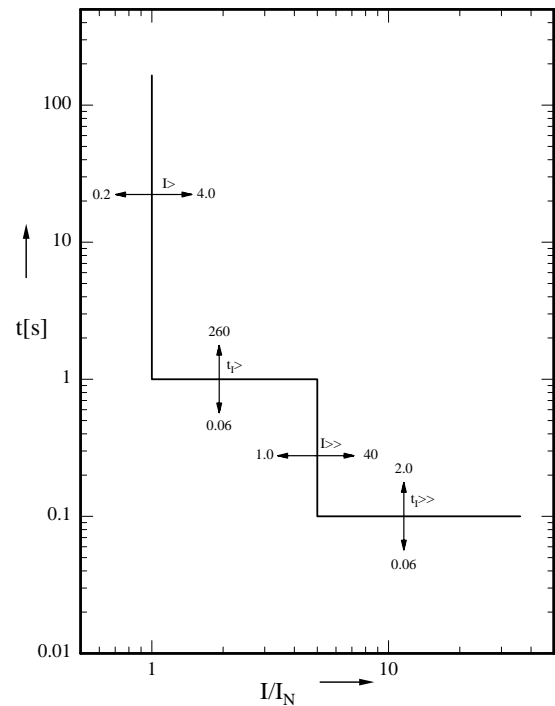

Figure 7.4: Definite time overcurrent relay

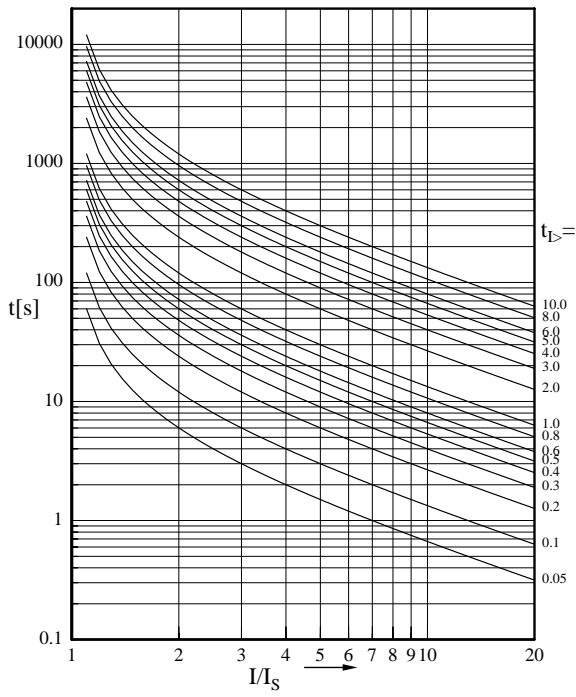

Figure 7.5: Long Time Inverse

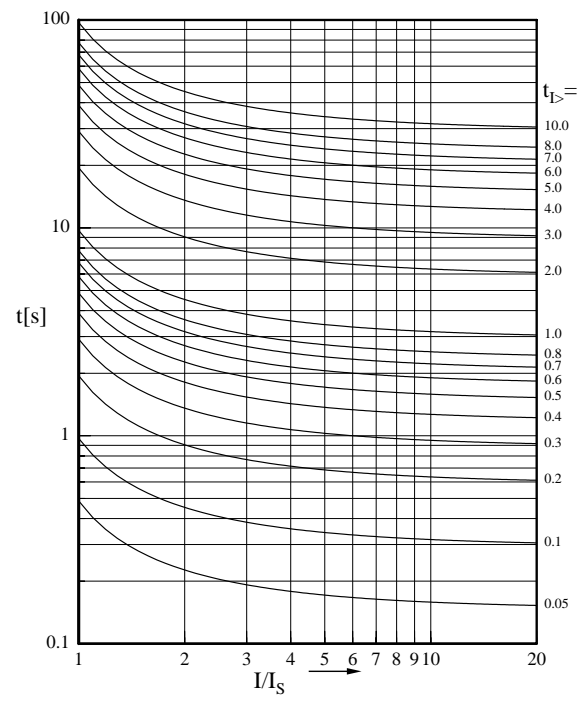

Figure 7.7: RHInverse

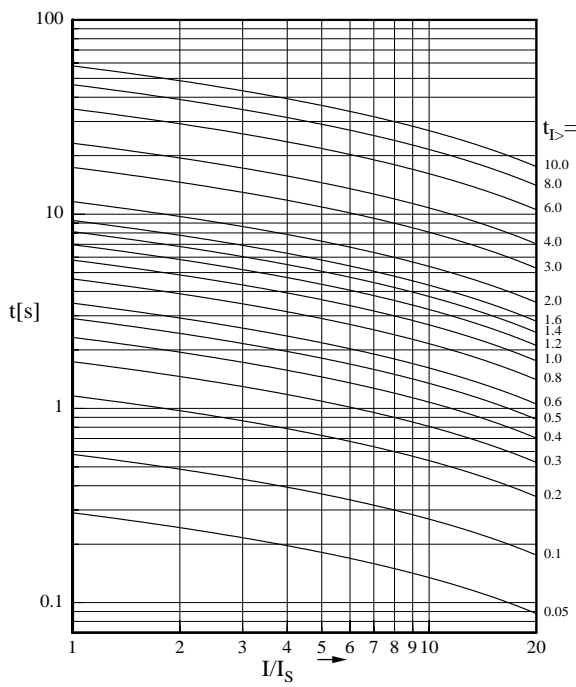

Figure 7.6: RXIDG characteristic

7.5 Output relays

Contacts: 2 change-over contacts for relay 1 and 2; 1 change-over contact for relay 3-4

Technical data subject to change without notice!

8 Order form

Time overcurrent- / earth fault current relay with harmonic stabilizing		MRI3-		H			
3-phase current I>, I>>							
Rated current	1 A		I1				
	5 A		I5				
Harmonic stabilizing							
Earth current	none				*		
	standard	1 A			E1		
		5 A			E5		
Rated current	sensitive	1 A			X1		
		5 A			X5		
Housing (12TE)	19"-rack					A	
	Flush mounting					D	
Communication protocol RS485 Pro Open Data; Modbus RTU							* -M

* Leave box empty if option is not desired

Setting list MRI3-IHE

Project: _____ SEG-job.-no.: _____

Function group: = _____ Location: + _____ Relay code: - _____

Relay functions: _____ Password: _____

Date: _____

Note !

All settings must be checked at site and should the occasion arise, adjusted to the object / item to be protected.

Setting of parameters

System parameter MRI3

Function		Default settings	Actual settings
$I_{\text{primär}}$ (Phase)	Illustration of the measured values as primary values in the display	SEK	
$I_{\text{primär}}$ (Erde)	Illustration of the measured values as primary values in the display	SEK	
50 / 60 Hz	Rated frequency	50Hz	
Display activation	Display of the excitation memory	FLSH	
P2	Parameterswitch/external triggering for fault recorder FR	SET1	

Parameter protection

Function	Unit	Default settings	Actual settings	
			Set 1	Set 2
	2 parameter sets		Set 1/Set 2	
IH2	Detection of the 2 nd harmonic	$\times I_N$	0.5	
I>	Pickup value for phase overcurrent	$\times I_N$	0.20	
I>IH2	Tripping value for phase current with detection of the 2 nd harmonic	$\times I_N$	0.20	
CHAR I>	Tripping characteristic for phase overcurrent element		DEFT	
tI>	Trip delay for phase overcurrent element	(s)	0.06	
I>+CHARI>	Reset Modus			
I>>	Pickup value for overcurrent high set element	$\times I_N$	1.00	
I>>IH2	Tripping value for short-circuit fast tripping with detection of the 2 nd harmonic	$\times I_N$	0.50	
tI>>	Trip delay for overcurrent high set element	s	0.06	
$I_{E>}$	Pickup value for earth fault low set element	$\times I_N$	0.01	
WARN/TRIP	Warning/tripping setting		TRIP	
CHAR I_E	Tripping characteristic for earth fault overcurrent element		DEFT	
tIE>	Trip delay for earth fault overcurrent element	(s)	0.06	
$I_{E>} + \text{CHAR } I_{E>} + t_{E>}$	RESET-Modus	s	0	
IE>>	Pickup value for earth fault high set element	$\times I_N$	0.01	
tIE>>	Trip delay for earth fault high set element	s	0.06	
Block/Trip	Block/Trip – tripping time	s	0.1	
t_{CBFP}	Trip time circuit breaker failure protection	X	EXIT	
RS*	Baud-Rate of serial interface		9600	
RS*	Parity check of serial interface		even	
RS	Slave Address of serial interface		1	

*only Modbus Protocol

Assignment of the blocking function:

Parameter switch	Default setting		Actual setting	
	Set 1	Set 2	Set 1	Set 2
Blocking the protection function PR_B	PR_B	PR_B		
Blocking the trip step TR_B				

Function	Default setting				Actual setting			
	Blocking		No blocking		Blocking		No blocking	
	Set 1	Set 2	Set 1	Set 2	Set 1	Set 2	Set 1	Set 2
I>			X	X				
I>>	X	X						
I _{E>}			X	X				
I _{E>>}			X	X				
t _{CBFP}			X	X				

Assignment of the output relays

Function	Relais 1		Relais 2		Relais 3		Relais 4	
	Default setting	Actual setting	Default setting	Actual setting	Default setting	Actual setting	Default setting	Actual setting
IH2 detection			X					
I> alarm			X					
I> trip	X							
I>> alarm					X			
I>> trip	X							
I _{E>} alarm							X	
I _{E>} trip	X							
I _{E>>} alarm							X	
I _{E>>} trip	X							
t _{CBFP} trip								

Parameter for the fault recorder

Function		Unit	Default settings	Actual settings
FR	Number of recordings		4	
FR	Saving of the recording at the occurrence		TRIP	
FR	Time prior to trigger impulse	s	0.05	
⌚	Year settings	Year	Y=00	
⌚	Month settings	Month	M=00	
⌚	Day settings	Day	D=00	
⌚	Setting of the hour	Hour	h=00	
⌚	Setting of the minute	Minute	m=00	
⌚	Setting of the second	Second	s=00	

Setting of code jumpers

Code jumper	J1		J2		J3	
	Default setting	Actual setting	Default setting	Actual setting	Default setting	Actual setting
Plugged						
Not plugged	X		No function		X	

Code jumper	Low/High-range for Reset Input		Low/High-range for blockage input	
	Default setting	Actual setting	Default setting	Actual setting
Low=plugged	X		X	
High=not plugged				

This technical manual is valid for the software version: D38-1.01 Pro Open Data Protocol
D88-1.01 Modbus Protocol



Schaltanlagen-Elektronik-Geräte GmbH & Co. KG
 Abteilung Gerätevertrieb / Electronic Devices Sales Department
 Krefelder Weg 47 · D - 47906 Kempen (Germany)
 Postfach 10 07 55 (P.O.B.) · D - 47884 Kempen (Germany)
 Tel.: +49 (0)21 52 1 45-1 · Fax.: +49 (0)21 52 1 45-3 54
 e-mail: electronics@avkseg.com