

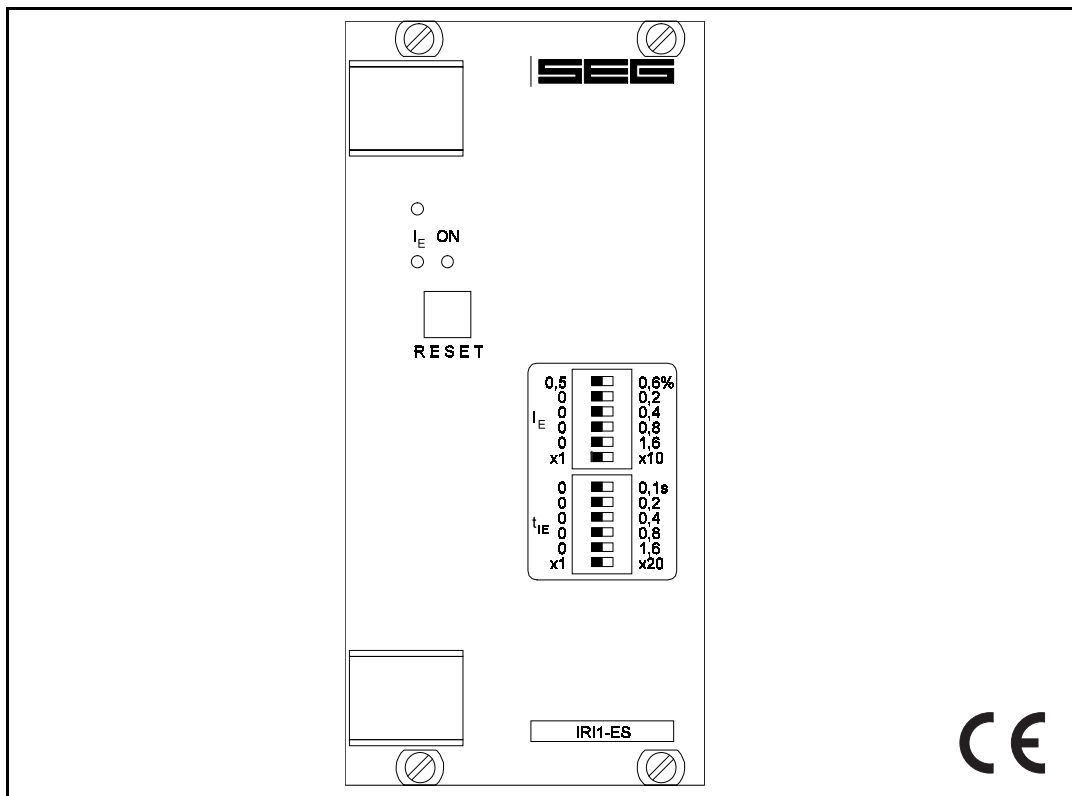

IRI1-ES - Sensitive Earth Fault Current Relay



Contents

1 Summary

2 Application

3 Characteristics and features

4 Design

- 4.1 Connections
- 4.2 Front plate
- 4.3 Code jumpers

5 Working principle

6 Operations and settings

- 6.1 Setting of the pickup value for the earth fault current I_E
- 6.2 Trip delay t_E
- 6.3 Reset

7 Housing

- 7.1 Individual housing
- 7.2 Rack mounting
- 7.3 Terminal connections

8 Relay testing and commissioning

- 8.1 Power-On
- 8.2 Checking the set values
- 8.3 Secondary injection test
- 8.4 Primary injection test
- 8.5 Maintenance

9 Technical Data

- 9.1 Measuring input
- 9.2 Auxiliary voltage
- 9.3 General data
- 9.4 Output relay
- 9.5 System data
- 9.6 Setting ranges and steps
- 9.7 Dimensional drawing

10 Order form

1 Summary

When compared with traditional protection systems the protective relaying with **MR**- and **IR**-relays of our *HIGH TECH LINE* offers several advantages.

All **MR** protection relays are based on microprocessor technology. They present the generation of our most efficient protection relays, because of their capabilities to process the measuring values digitally and to perform arithmetical and logical operation. Additional advantages such as very low power consumption, adaptability, possibilities for self-supervision, flexible construction, selection of relay characteristics are completely utilized.

Some **IR** protection relays are based on microprocessor and some like the **IR11-ES** on analog technology. They present our low-priced protection relay generation and are used for all basic protection application.

The following properties of the **IR** protection relays, such as:

- Integration of multiple protection functions into one compact housing,
- User-friendly setting procedure by means of DIP-switches,
- Compact design due to SMD-technique,

are their superiority over the traditional protection systems.

For all applications of a more complex nature, e.g. directional earth fault detection and where operating convenience, fault analysis and communication ability are required, **MR**-relays are used.

All relays of the *HIGH TECH LINE* are available for through panel mounting and in 19" racks. Connection terminals are of plug-in type. All IEC/DIN regulations required for the individual application are reliably met by these relays.

2 Application

The sensitive earth fault relay **IR11-ES** detects high impedance earth faults with very small currents. Conventional earth fault relays (IDMT) do not provide the required sensitivity.

For this application the **IR11-ES** is the optimal solution.

3 Characteristics and features

- Static protective device
- Earth fault detection with core balance C.T. or in Holmgreen circuit
- Low pass filter for suppression of harmonics
- Coding for the self-holding function or automatic reset of the LED's and trip relays
- Frequency range 50/60 Hz
- Rated current 1A or 5A
- Output relay with 2 change-over contacts
- Extremely large setting range for current reaction value with fine grading
- Wide range of operation of the supply voltage (AC/DC)

4 Design

4.1 Connections

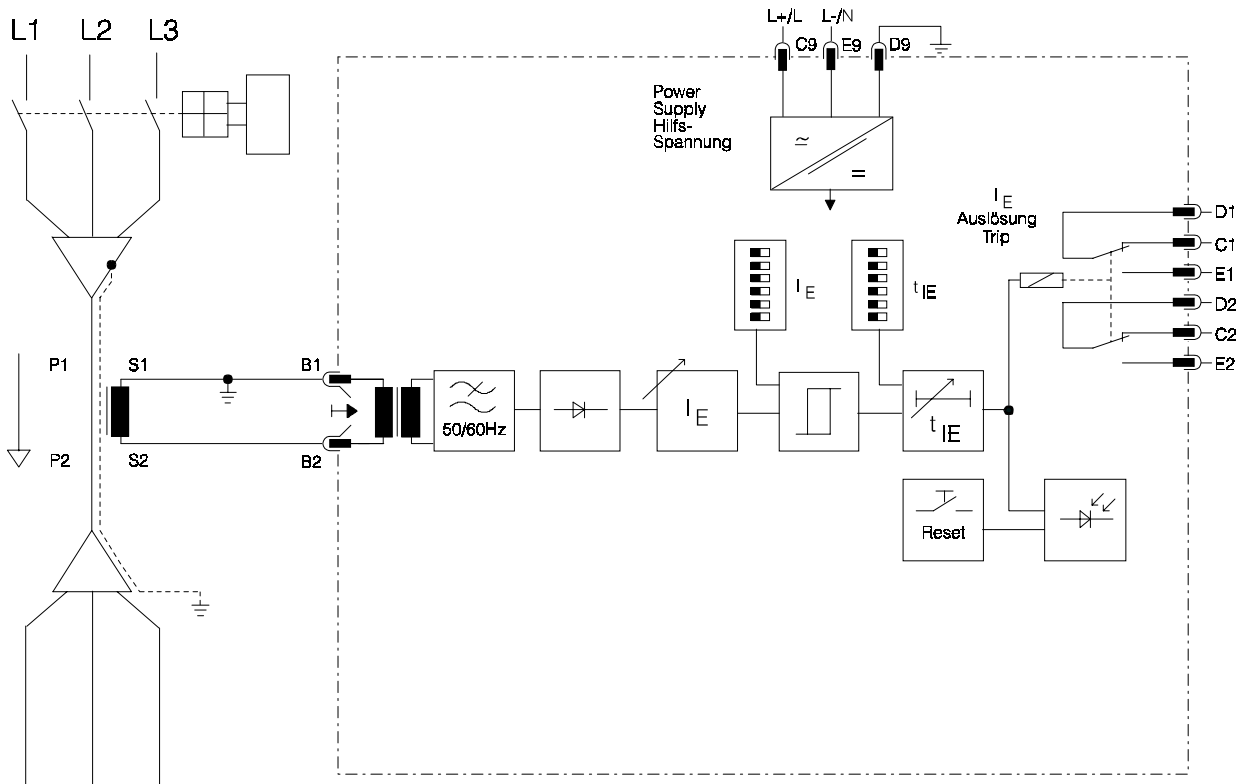

Fig. 4.1: Connection diagram of IRI1-ES

4.1.1 Current measuring input

The analog input signal of the earth fault current is fed to the terminals B1/B2 of the protection relay.

4.1.2 Output relay

The IRI1-ES has one output relay with two change-over contacts:

State of IRI1-ES	Contact terminals closed:
Normal operation, pickup and dead condition	D1-C1, D2-C2
Trip	D1-E1, D2-E2

4.2 Front plate

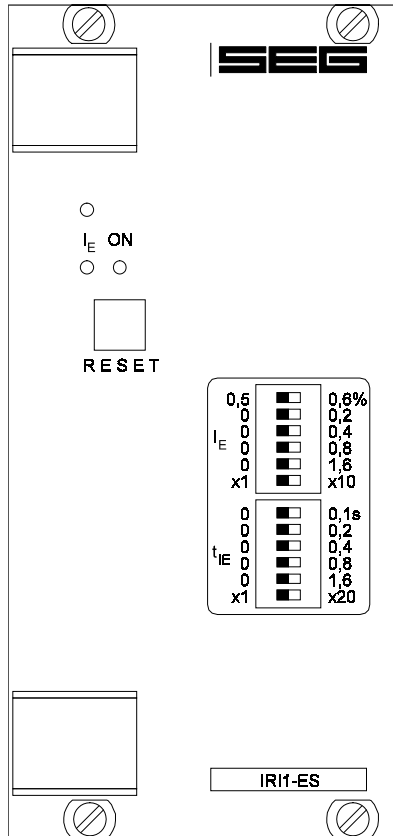

Fig. 4.2: Front plate

The front plate of the *IRI1-ES* comprises the following operation and indication elements:

- 2 sets of DIP-switches for setting the current pickup value and the trip delay
- 3 LEDs for indication of faults- and readiness for operation
- 1 <RESET> push button

4.2.1 LEDs

On the front plate of the *IRI1-ER* 2 LEDs are installed, signaling the following 2 service conditions:

- LED ON (green): readiness for service
- LED I_E (yellow): pickup
- LED I_E (red): tripping

4.2.2 DIP-switches

The set of DIP switches on the front plate serves for setting the tripping value for the earth fault current I_E and the trip delay t_{IE} .

4.2.3 <RESET>-push button

The <RESET> push button is used for acknowledgement and reset of the LED and the tripping relay after tripping at the specifically presetting (see 4.3).

4.3 Code jumpers

There are two code jumpers behind the front plate which determine the function of the <RESET> pushbutton with regard to the LED indication and the output relay.

The following table explains the coding possibilities.

Code jumper	Reset function	Reset
3	ON	Earth fault indication
	OFF	LED I_E (red)
4	ON	Earth fault trip
	OFF	Relays

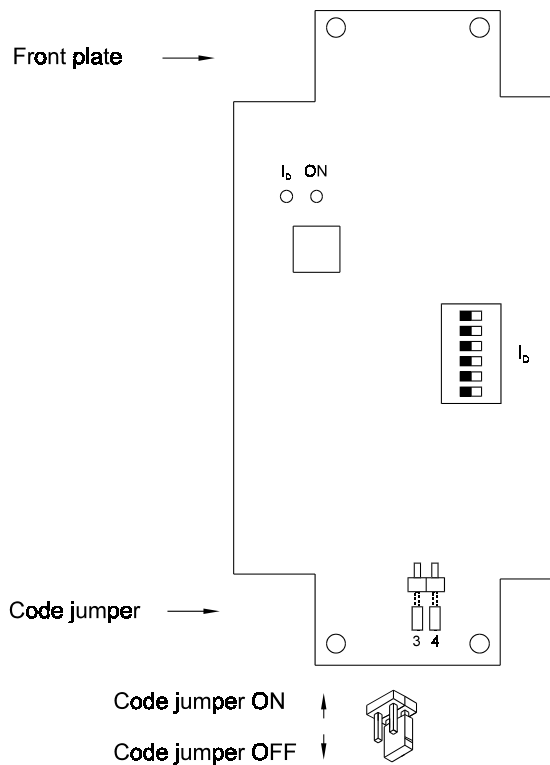

Fig. 4.3: Code jumpers

5 Working principle

The earth fault protection relay *IR11-ES* can be connected into the differential path of the C. T.s in a Holgreen circuit or connected to a core balance C.T.

The analog measuring current is galvanically isolated and then fed to a low pass filter to suppress harmonics. Thereafter the signal is rectified and fed to a comparator where it is continuously compared with the preset threshold. If the measuring current exceeds a preset pickup value, the relay trips after the set trip delay has elapsed (see 4.1).

6 Operations and settings

6.1 Setting of the pickup value for the earth fault current I_E

The pick-up value of the earth fault current element I_E can be set by means of the DIP-switches set I_E in the range of 0.5% to 36% $\times I_N$ with a grading of 0.1%.

The pick-up value is calculated by adding up the values of all DIP-switches.

Example:

A pick-up value of 10% of the rated current is required.

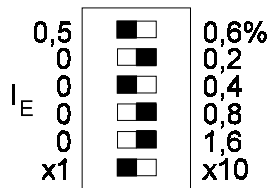

Fig. 6.1: Setting example for the earth fault current pickup value

6.2 Trip delay t_E

The of the earth fault element can be set by means of the DIP-switches set t_E in the range of 2.0 s to 62 s with a grading of 0.1 s or 0.2 s.

The trip delay is calculated by adding up the values of all DIP-switches.

Example:

A trip delay of 2.5 s is required.

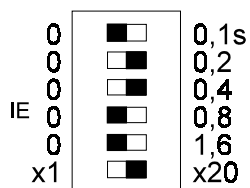

Fig. 6.2: Setting example for the trip delay

6.3 Reset

Dependent on the code jumper's position (see 4.3) the relay can be reset manually by the <RESET> pushbutton. If the function is coded for automatic reset, the LED extinguishes and the output relay releases automatically after fault clearance.

7 Housing

The *IR11* can be supplied in an individual housing for flush-mounting or as a plug-in module for installation in a 19" mounting rack according to DIN 41494. Both versions have plug-in connections.

Relays of variant D are complete devices for flush mounting, whereas relays of variant A are used for 19" rack mounting. Housing variant A to be installed in switchboards of protection class IP51. For switchboards of lower protection classes housing variant D can be used.

7.1 Individual housing

The individual housing of the *IR11* is constructed for flush-mounting. The dimensions of the mounting frame correspond to the requirements of DIN 43700 (72 x 144 mm). The cut-out for mounting is 68 x 138 mm.

The front of the *IR11* is covered with a transparent, sealable flap (IP54).

For case dimensions and cut-out refer to "technical data". The individual housing is fixed with the supplied clasps from the rear of the switchboard panel.

7.2 Rack mounting

The *IR11* is in general suitable for installation in a modular carrier according to DIN 41494. The installation dimensions are: 12 TE; 3 HE.

According to requirements, the *IR11*-devices can be delivered mounted in 19" racks.

7.3 Terminal connections

The plug-in module has very compact base with plug connectors and screwed-type connectors.

- max. 15 poles screw-type terminals for voltage and current circuits (terminal connectors series A and B with a short time current capability of 500 A / 1 s).
- 27 poles tab terminals for relay outputs, supply voltage etc. (terminal connectors series C, D and E, max. 6 A current carrying capacity). Connection with tabs 6.3 x 0.8 mm for cable up to max. 1.5 mm² or with tabs 2.8 x 0.8 mm for cable up to max. 1 mm².

By using 2.8 x 0.8 mm tabs a bridge connection between different poles is possible.

The current terminals are equipped with self-closing short-circuit contacts. Thus, the *IR11*-module can be unplugged even with current flowing, without endangering the current transformers connected.

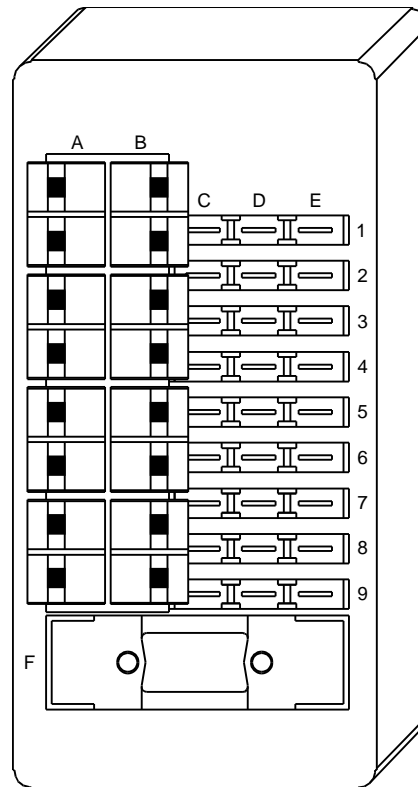

Fig. 7.1: Terminal block

8 Relay testing and commissioning

The following test instructions should help to verify the protection relay performance before or during commissioning of the protection system. To avoid a relay damage and to ensure a correct relay operation, be sure that:

- the auxiliary power supply rating corresponds to the auxiliary voltage on site.
- the rated current and rated voltage of the relay correspond to the plant data on site.
- the current transformer circuits are connected to the relay correctly.
- all signal circuits and output relay circuits are connected correctly.

8.1 Power-On

NOTE!

Prior to switch on the auxiliary power supply, be sure that the auxiliary supply voltage corresponds with the rated data on the type plate.

Switch on the auxiliary power supply to the relay (terminals C9/E9) and check that the LED "ON" on the front lights up green.

8.2 Checking the set values

Check all relay set values and see if they are set correctly as you have desired. Set values can be modified by means of the DIP-switches on the front.

8.3 Secondary injection test

8.3.1 Test equipment

- Ammeter with class 1 or better
- Auxiliary power supply with the voltage corresponding to the rated data on the type plate
- Single-phase current supply unit (adjustable from 0 to $1.0 \times I_N$)
- Timer to measure the operating time (Accuracy ± 10 ms)
- Switching device
- Test leads and tools

8.3.2 Example of test circuit for IR11 relays

For testing *IR11-ES* relays, only current input signals are required. Figure 8.1 shows a simple example of a single phase test circuit with adjustable current energizing the *IR11-ES* relay under test.

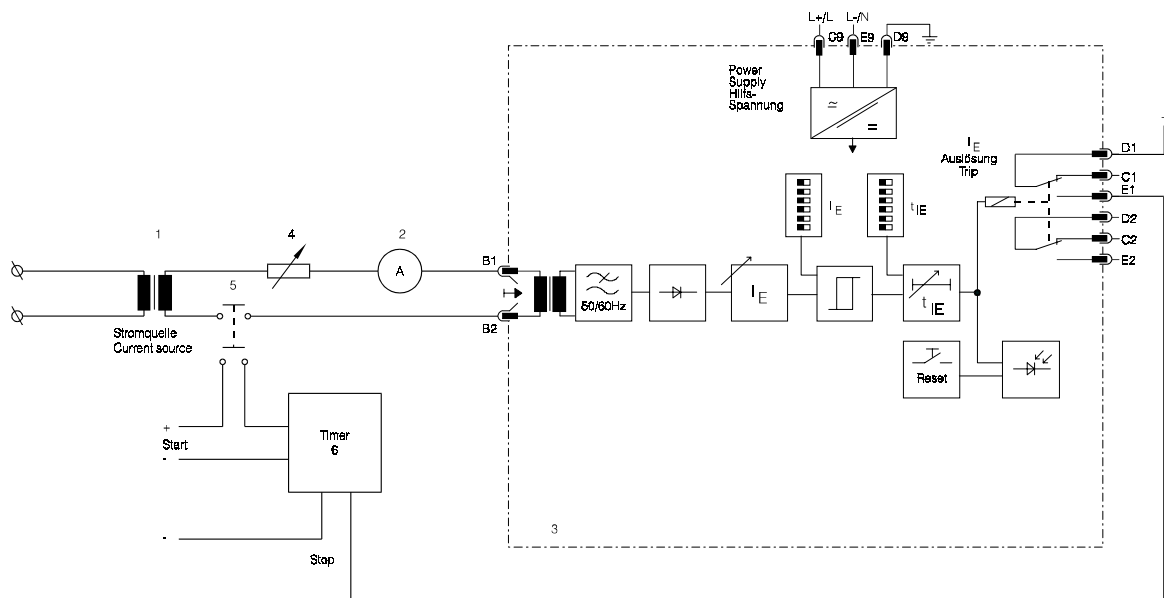

1. Stromquelle
Current source
2. Strommesser
Ammeter
3. zu testendes Relais
Relay under test
4. Potentiometer
adjust. resistor
5. Schaltgerät
Switching device
6. Zeitgeber
Timer

Fig. 8.1: Example of a test circuit for IR11-ES

8.3.3 Checking the pickup and tripping values

With the *IR11-ES*, the analog input signal of the single-phase testing AC must be supplied to the relay via the terminals B1/B2 for checking the pickup value I_E .

For testing the earth fault current pickup value, first the testing AC must be set below the set pickup value I_E . Then the testing AC is increased gradually, until the relay picks up. This is indicated by the LED I_E lighting up yellow at the same time. Check that the value shown at the ammeter does not deviate by more than $\pm 5\%$ from the set pickup value I_E .

The resetting value of the earth fault element is determined, by slowly decreasing the testing AC, until the output relay I_E releases. The LED I_E extinguishes (supposed the respective coding was effected).

Check that the resetting value is not greater than 0.95 times the pickup value.

8.3.4 Checking the trip delay t_E

To check the trip relay, a timer must be connected to the trip output relay contact. The timer should be started simultaneously with the current injection into the current input circuit and stopped by the trip relay contact. Set the current to a value corresponding to twice the operating value and inject the current instantaneously. The operating time measured by the timer should have a deviation of less than $\pm 3\%$ of the set value or ± 20 ms.

8.4 Primary injection test

Generally, a primary injection test could be carried out in the similar manner as the secondary injection test described above. With the difference that the protected power system should be, in this case, connected to the installed relays under test „on line“, and the test currents and voltages should be injected to the relay through the current and voltage transformers with the primary side energized. Since the cost and potential hazards are very high for such a test, primary injection tests are usually limited to very important protective relays in the power system.

8.5 Maintenance

Maintenance testing is generally done on site at regular intervals. These intervals vary among users depending on many factors: e.g. the type of protective relays employed; the importance of the primary equipment being protected; the user's past experience with the relay, etc.

For static relays such as the *IR11-ES*, maintenance testing once per year is sufficient, as experience has shown.

9 Technical Data

9.1 Measuring input

Rated data:

Nominal current I_N 1 A/5 A
 Nominal frequency f_N 50/60 Hz

Power consumption in current circuit: <1 VA/at $I_N = 1 A$
 <5 VA/at $I_N = 5 A$

Thermal withstand capability of current circuit

dynamic current withstand (half-wave)	250 x I_N
for 1 s	100 x I_N
for 10 s	30 x I_N
continuously	4 x I_N

9.2 Auxiliary voltage

Rated auxiliary voltage U_H :
 24 V - working range 16 - 60 V AC / 16 - 80 V DC
 110 V - working range 50 - 270 V AC / 70 - 360 V DC

Power consumption:
 24 V - working range standby approx. 3 W operating approx. 6 W
 110 V - working range standby approx. 3 W operating approx. 6 W

9.3 General data

Permissible interruption of the supply voltage without influence on the function 50 ms
 Dropout to pickup ratio: >95%
 Returning time: 30 ms
 Minimum operating time: 30 ms

9.4 Output relay

The output relay has the following characteristics:

Maximum breaking capacity: 250 V AC / 1500 VA / continuous current 6 A

Breaking capacity for DC:

	ohmsch	L/R = 40 ms	L/R = 70 ms
300 V DC	0.3 A / 90 W	0.2 A / 63 W	0.18 A / 54 W
250 V DC	0.4 A / 100 W	0.3 A / 70 W	0.15 A / 40 W
110 V DC	0.5 A / 55 W	0.4 A / 40 W	0.20 A / 22 W
60 V DC	0.7 A / 42 W	0.5 A / 30 W	0.30 A / 17 W
24 V DC	6.0 A / 144 W	4.2 A / 100 W	2.50 A / 60 W

Max. rated making current 64 A (acc. VDE 0435/0972 and IEC 65 / VDE 0860 / 8.86)
 Making current: minimum 20 A (16ms)
 Mechanical life span: 30 x 10⁶ switching cycles
 Electrical life span: 2 x 10⁵ switching cycles at 220 V AC / 6 A
 Contact material: silver-cadmium-oxyde

9.5 System data

Design standard:	
Generic standard:	EN 50082-2, EN 50081-1
Product standard:	EN 60255-6, IEC 255-4, BS 142
Specified ambient service	
Storage temperature range:	- 40°C to + 85°C
Operating temperature range:	- 20°C to + 70°C
Environmental protection class F as per DIN 40040 and per DIN IEC 68 2-3:	relative humidity 95 % at 40°C for 56 days
Insulation test voltage, inputs and outputs between themselves and to the relay frame as per EN 60255-6 and IEC 255-5:	2.5 kV (eff.), 50 Hz; 1 min
Impulse test voltage, inputs and outputs between themselves and to the relay frame as per EN 60255-6 and IEC 255-5:	5 kV; 1.2 / 50 µs; 0.5 J
High frequency interference test voltage, inputs and outputs between themselves and to the relay frame as per EN 60255-6 and IEC 255-22-1:	2.5 kV / 1MHz
Electrostatic discharge (ESD) test as per EN 61000-4-2 and IEC 255-22-1:	8 kV air discharge, 6 kV contact discharge
Electrical fast transient (Burst) test as per EN 61000-4-8 and IEC 801-4:	4 kV / 2.5 kHz, 15 ms

Power frequency magnetic field test as per ENV 50141:	electric field strength 10 V/m
Surge immunity EN 61000-4-5:	4 kV
Radio interference suppression test as per EN 55011:	limit value class B
Radio interference radiation test as per EN 55011:	limit value class B
Mechanical tests:	
Shock:	class 1 acc. to DIN IEC 255-21-2
Vibration:	class 1 acc. to DIN IEC 255-21-1
Degree of protection - front of relay:	IP 54 by enclosure of the relay case and front panel (relay version D)
Weight:	approx. 1.5 kg
Degree of pollution:	2 by using housing type A 3 by using housing type D
Overvoltage class:	III
Influence variable values:	
Frequency influence:	40 Hz < f < 70 Hz: <3 % of set value
Temperature influence:	-20°C bis +70°C
Auxiliary voltage influence:	no influence within the admissible range
GL-Approbation:	99 324-97 HH

9.6 Setting ranges and steps

Parameter	Setting range	Steps	Tolerances
I_E	0,5 % ... 3,6 % x I_N 5,0 % ... 36 % x I_N	0,1 % 1,0 %	± 5 % vom Einstellwert
t_{IE}	0,1 s ... 3,1 s 2,0 s ... 62 s	0,1 s 2,0 s	± 3 % bzw. ± 20 ms

9.7 Dimensional drawing

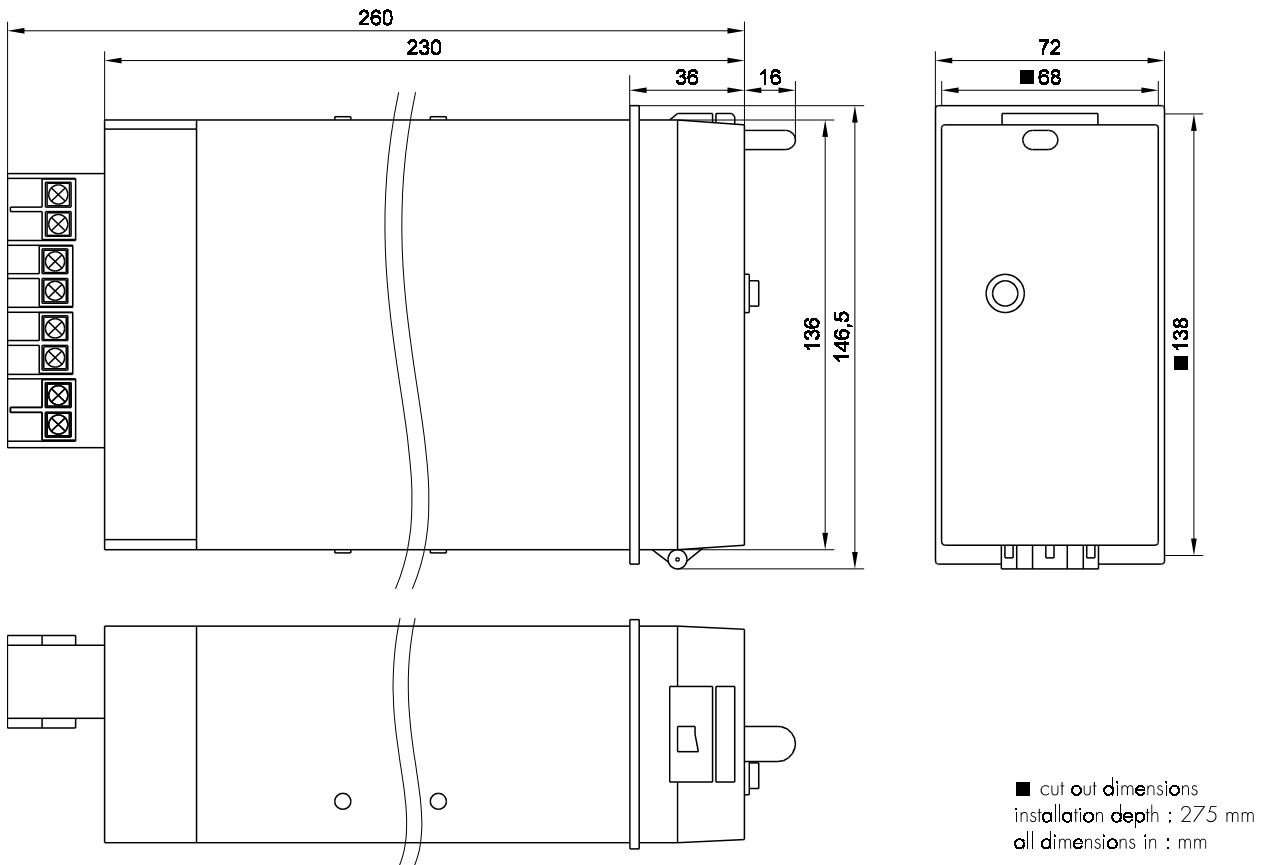

Please note:

A distance of 50 mm is necessary when the units are mounted one below the other in order to allow easy opening of the front cover of the housing. The front cover opens downwards.

10 Order form

Sensitive earth fault relay		IRI1-	ES				
Rated current	1 A			1	L	A	
	5 A			5			H
Auxiliary voltage	24 V (16 to 60 V AC / 16 to 80 V DC)						
	110 V (50 to 270 V AC / 70 to 360 V DC)						
Housing (12TE)	19" Rack					D	
	Flush mounting						

Technical data subject to change without notice !

Setting list IR11-ES

Note !

All settings must be checked at site and should the occasion arise, adjusted to the object / item to be protected.

Project: _____ SEG job.-no.: _____

Function group: ≡ _____ Location: ± _____ Relay code: - _____

Relay functions: _____

Setting of parameters

Parameter		Unit	Default settings	Actual settings
I_E	Earth fault current	% In	0.5	
t_{IE}	Tripping delay I_E	s	0.1	

Setting of code jumpers

Code jumper	J1		J2		J3		J4	
	Default setting	Actual setting	Default setting	Actual setting	Default setting	Actual setting	Default setting	Actual setting
Plugged					X		X	
Not plugged	not used		not used					



Schaltanlagen-Elektronik-Geräte GmbH & Co. KG

Abteilung Gerätevertrieb / Electronic Devices Sales Department

Krefelder Weg 47 · D - 47906 Kempen (Germany)

Postfach 10 07 67 (P.O.B.) · D - 47884 Kempen (Germany)

Tel.: +49 (0)21 52 1 45-1 · Fax.: +49 (0)21 52 1 45-3 54

e-mail: electronics@avksege.com